

CA 6161 CA 6163



Machine and panel tester

You have just purchased a **CA 6161 or CA 6163 machine and panel tester** and we thank you for your trust.

For best results from your instrument:

- **read** this user manual carefully,
- **comply** with the precautions for use.



WARNING, risk of DANGER! The operator must refer to these instructions whenever this danger symbol appears.



CAUTION, risk of electric shock. The voltage applied to parts marked with this symbol may be hazardous.



Instrument protected by double insulation.



Current clamp.



USB plug.



Useful information or tip.



Chauvin Arnoux has designed this instrument in the context of a global Eco-Design approach. A life cycle analysis was carried out to master and optimise the impact of this product on the environment. More precisely, the product exceeds the requirements of regulations as regards recycling and valuation.



The product is declared recyclable following an analysis of the life cycle in accordance with standard ISO 14040.



The CE marking indicates compliance with the European Low Voltage Directive (2014/35/EU), the Electromagnetic Compatibility Directive (2014/30/EU), the Directive on Radioelectric Equipment (2014/53/EU) and the Directive on the Restriction of Hazardous Substances (RoHS, 2011/65/EU and 2015/863/EU).



The UKCA marking certifies that the product is in compliance with the requirements applicable in the United Kingdom as regards Low Voltage, Electromagnetic Compatibility, and Restriction of Hazardous Substances.



The rubbish bin with a line through it means that in the European Union, the product must undergo selective disposal in compliance with Directive WEEE 2012/19/EU.

CONTENTS

1. COMMISSIONING	6	8. TECHNICAL CHARACTERISTICS	97
1.1. CA 6161 delivery condition	6	8.1. General terms of reference.....	97
1.2. CA 6163 delivery condition	7	8.2. Electrical characteristics	97
1.3. Accessories	8	8.3. Variations in the field of use.....	108
1.4. Spares	8	8.4. Power supply	112
1.5. Choice of language.....	9	8.5. Environmental conditions	112
2. INSTRUMENT PRESENTATION	10	8.6. Communication	113
2.1. CA 6161	10	8.7. Mechanical characteristics	113
2.2. Opening the cover	10	8.8. Compliance with international standards.....	113
2.3. CA 6163.....	11	8.9. Electromagnetic compatibility (EMC).....	113
2.4. Keys.....	11	8.10. Radio emissions	113
2.5. Instrument features	12	8.11. GPL code	113
2.6. Display.....	12	9. MAINTENANCE	114
2.7. Connectors	13	9.1. Cleaning	114
2.8. Terminals	13	9.2. Fuse replacement.....	114
3. CONFIGURATION	14	9.3. Replacement of the TEST SOCKET.....	115
3.1. General.....	14	9.4. Storing the instrument	116
3.2. Starting up	14	9.5. Resetting the instrument.....	116
3.3. Screen calibration.....	15	9.6. Updating the embedded software.....	116
3.4. User profiles	15	9.7. Calibrating the instrument.....	118
3.5. Configuring the instrument	17	9.8. Memory check	120
4. USE	19	10. WARRANTY	121
4.1. Keys.....	19	11. APPENDIX	122
4.2. Visual inspection.....	19	11.1. Definition of symbols.....	122
4.3. Sound signal.....	20	11.2. Earth connection diagrams	125
4.4. Instrument temperature	20	11.3. Fuse table	126
4.5. Connection	20		
4.6. Start / Stop button.....	21		
4.7. Measurement duration.....	21		
4.8. Continuity measurement.....	22		
4.9. Insulation measurement resistance.....	29		
4.10. Dielectric test	33		
4.11. Differential test (RCD).....	42		
4.12. Loop impedance measurement (Zs)	50		
4.13. Line impedance measurement (Zl).....	55		
4.14. Power measurement	59		
4.15. Power and leakage current measurement (CA 6163)	64		
4.16. Leakage current measurement.....	68		
4.17. Contact current measurement (CA 6163).....	74		
4.18. Phase rotation	79		
4.19. Discharge time.....	82		
4.20. Auto Script	86		
5. USE OF ACCESSORIES	88		
5.1. Printer	88		
5.2. Barcode reader	88		
5.3. RFID receiver	88		
5.4. Wiring extension connectors	89		
5.5. Lamp tower.....	90		
5.6. Pedal	90		
5.7. Door Checker	90		
6. MEMORY FUNCTION	91		
6.1. Memory organisation	91		
6.2. Saving a measurement.....	92		
6.3. Review of recordings.....	94		
6.4. Memory management.....	95		
6.5. Errors.....	95		
7. MTT APPLICATION SOFTWARE	96		
7.1. Get MTT	96		
7.2. Install MTT.....	96		
7.3. Using MTT	96		

Definition of measurement categories

- Measurement category IV (CAT IV) corresponds to measurements taken at the source of low-voltage installations.
Example: power feeds, meters and protection devices.
- Measurement category III (CAT III) corresponds to measurements on building installations.
Example: distribution panel, circuit-breakers, stationary machines or fixed industrial devices.
- Measurement category II (CAT II) corresponds to measurements taken on circuits directly connected to low-voltage installations.
Example: power supply to domestic appliances and portable tools.

Example to identify the locations of measurement categories

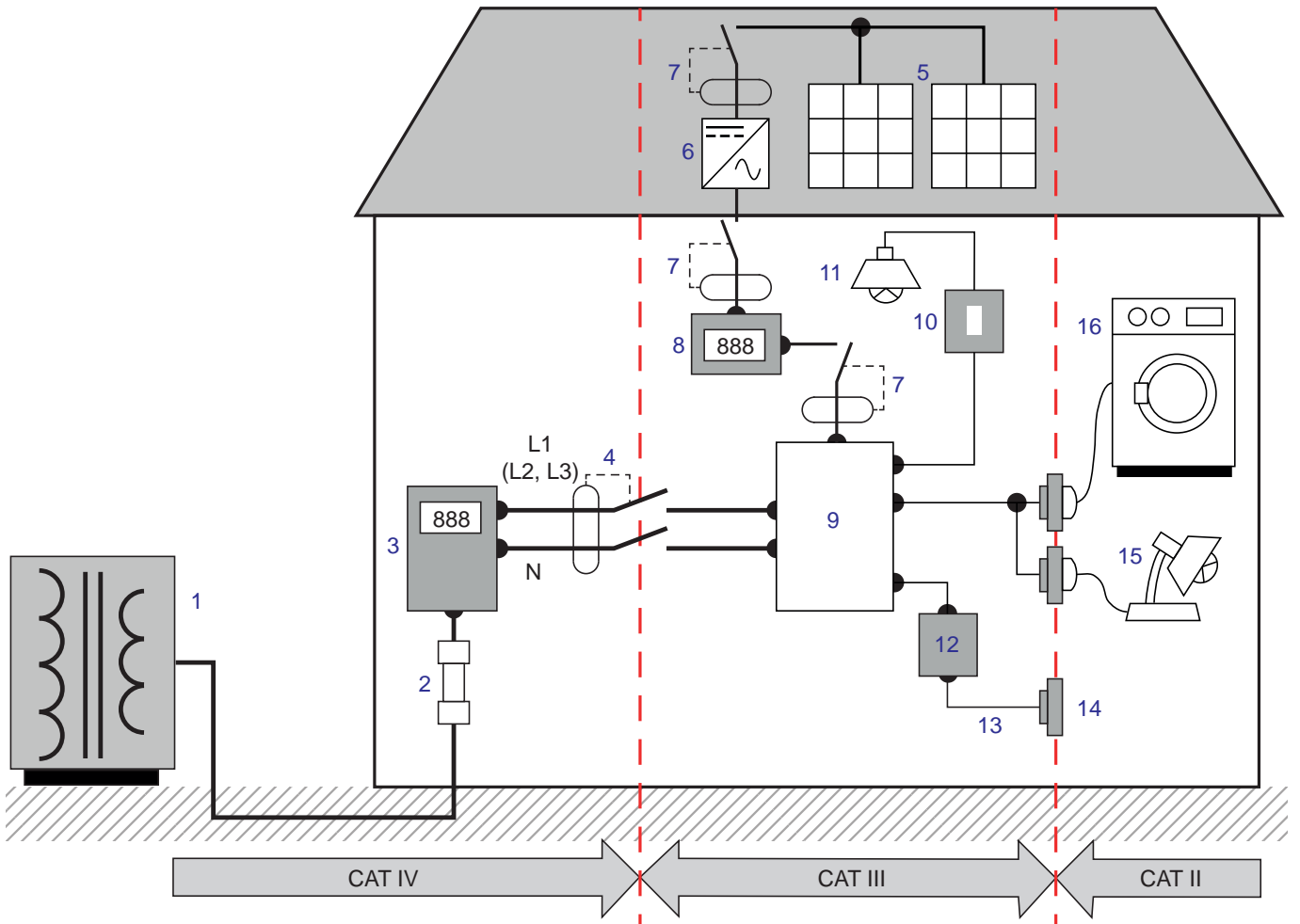

- | | |
|--|---|
| 1 Low-voltage supply source over or under ground | 9 Distribution board |
| 2 Service fuse | 10 Light switch |
| 3 Tariff meter | 11 Lighting |
| 4 Mains circuit breaker or isolator switch * | 12 Junction box |
| 5 Photovoltaic panel | 13 Socket wiring |
| 6 DC to AC inverter | 14 Socket outlets |
| 7 Circuit breaker or isolator switch | 15 Plug-in lamps |
| 8 Generation meter | 16 Household appliances, portable tools |

* : The mains circuit breaker or isolator switch may be installed by the service provider. If not, the demarcation point between CAT IV and CAT III is the first isolating switch in the distribution board.

PRECAUTIONS FOR USE

This instrument complies with the safety standard IEC/EN 61010-2-034 or BS EN 61010-2-034.

Failure to observe the precautions for use may create a risk of electric shock, fire, explosion, and/or destruction of the instrument and of the installations.

- The operator and/or the responsible authority must carefully read and clearly understand the various precautions to be taken in use. Sound knowledge and a keen awareness of electrical hazards are essential when using this instrument.
- If you use this instrument other than as specified, the protection it provides may be compromised, thereby endangering you.
- Do not use the instrument on networks whose voltage or category exceeds those mentioned.
- Do not use the instrument if it seems to be damaged, incomplete, or poorly closed.
- Before each use, check the condition of the insulation on the leads, housing, and accessories. Any item whose insulation is deteriorated (even partially) must be set aside for repair or scrapping.
- Before using your instrument, check that it is completely dry. If it is wet, it must be thoroughly dried before it can be connected or used.
- Keep your hands away from the terminals of the instrument.
- Use only the leads and accessories supplied. The use of leads (or accessories) of a lower voltage or category limits the voltage or category of the combined instrument and leads (or accessories) to that of the leads (or accessories).
- When handling the leads, test probes, and crocodile clips, keep your fingers behind the physical guard.
- Do not perform continuity, insulation measurements and dielectric tests on live installations.
- Use personal protection equipment systematically.
- All troubleshooting and metrological checks must be performed by competent and accredited personnel.

1. COMMISSIONING

1.1. CA 6161 DELIVERY CONDITION

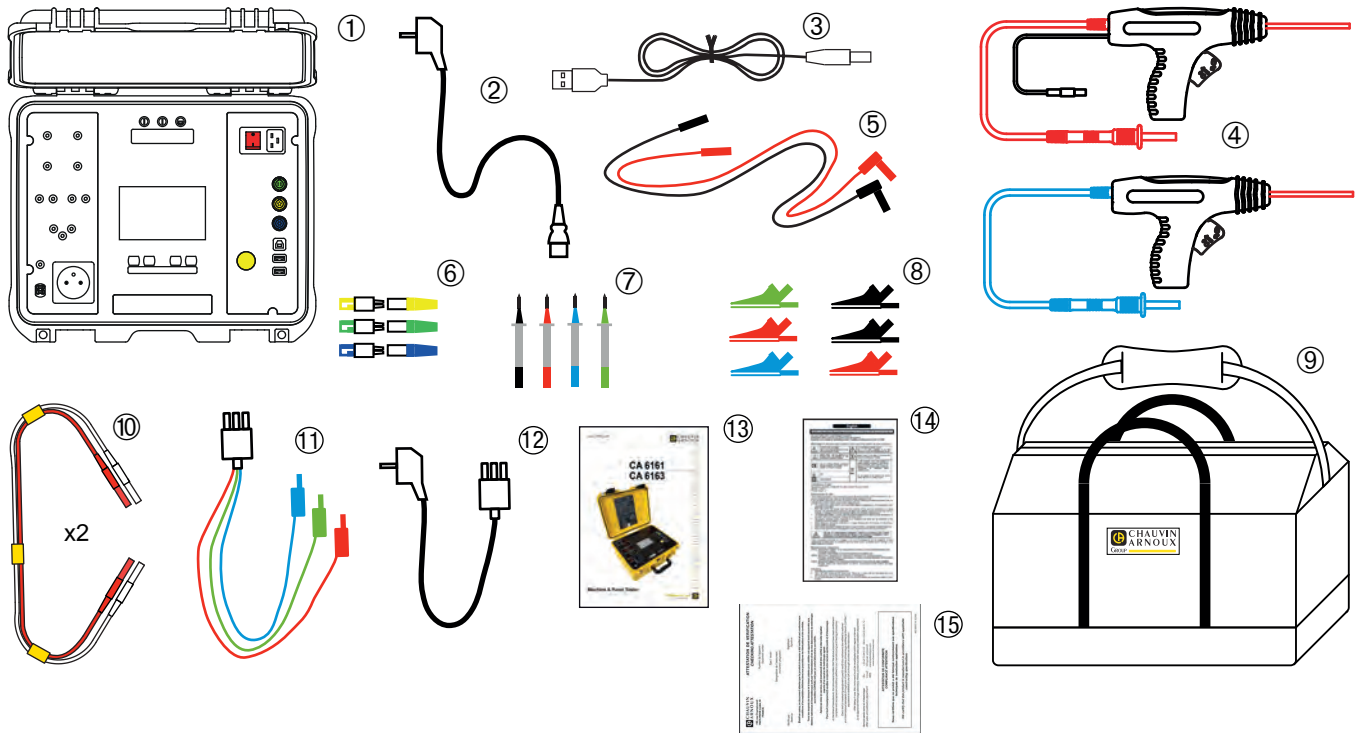

Figure 1

- ① One CA 6161
- ② One C19 - Schuko power cord, length 2.5 m.
- ③ One USB A/B cord.
- ④ Two high voltage pistols (red and blue) with a 3 m cable.
- ⑤ Two right-angled safety cords (red and black), length 3 m.
- ⑥ Three extension connectors (green, yellow, blue)
- ⑦ Four test probes (black, red, green and blue).
- ⑧ Six crocodile clips (2 red, 2 black, 1 green and 1 blue).
- ⑨ One carrying case.
- ⑩ Two dual continuity cords, length 3 m.
- ⑪ One tripod cord - 3 safety cords, length 2.5 m.
- ⑫ One tripod cord - Schuko, length 2.5 m.
- ⑬ One multilingual quick start guide.
- ⑭ One multilingual safety data sheet
- ⑮ One test report.

1.2. CA 6163 DELIVERY CONDITION

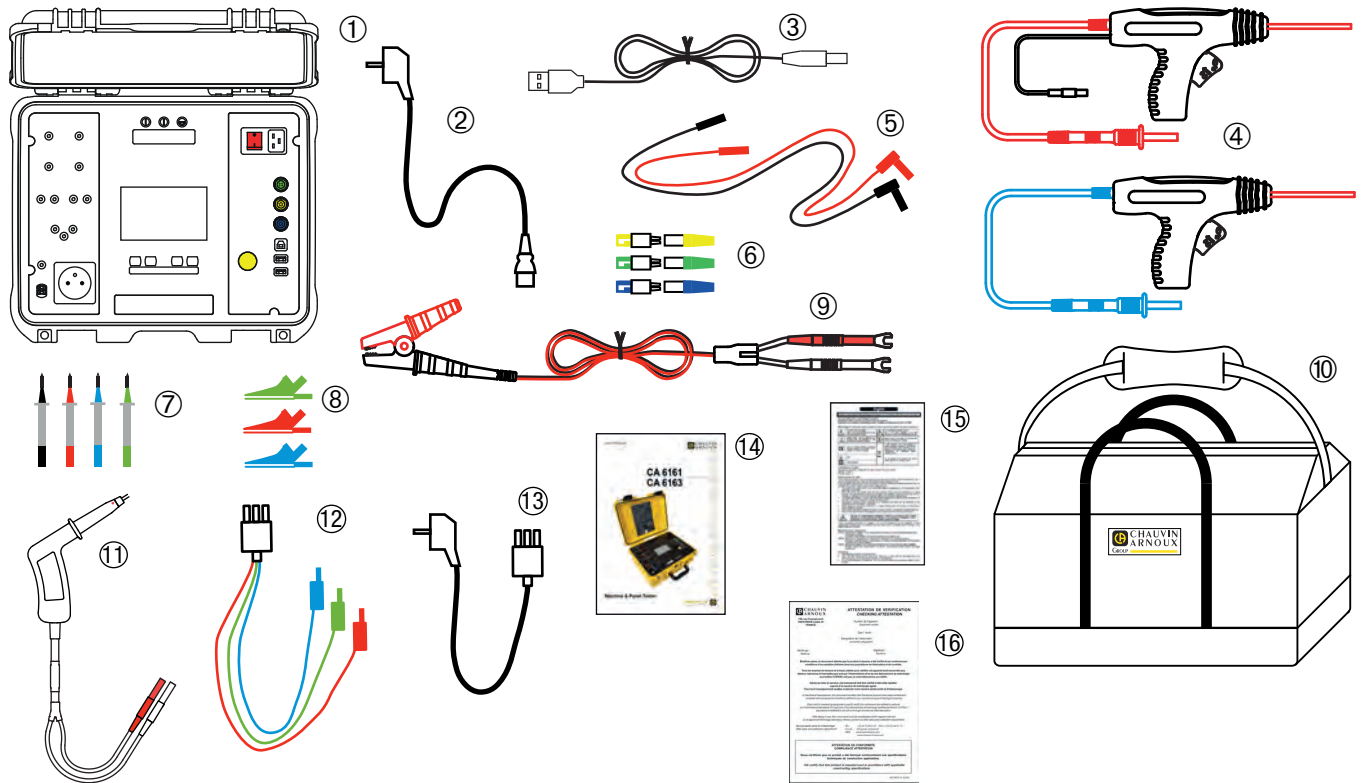
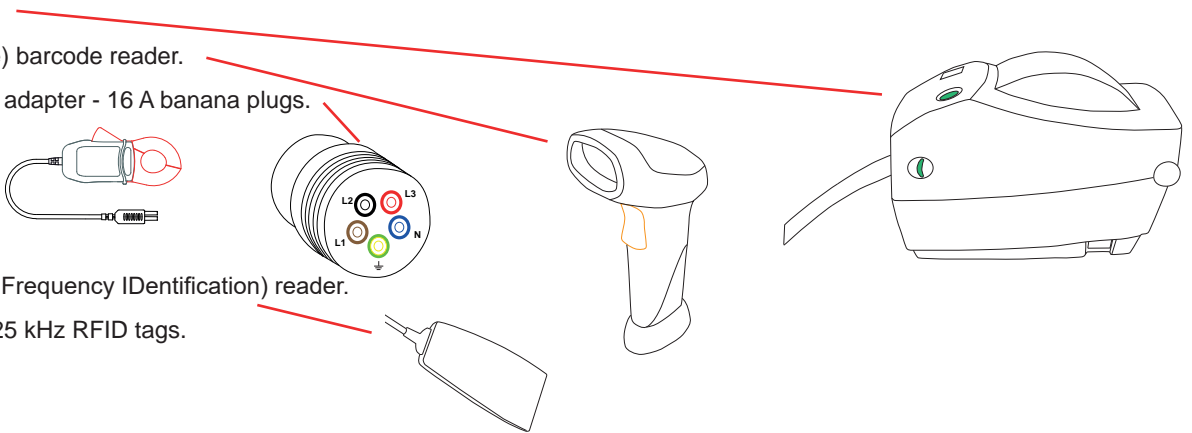
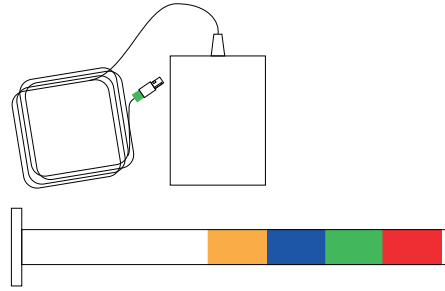

Figure 2

- ① One CA 6163
- ② One C19 - Schuko power cord, length 2.5 m.
- ③ One USB A/B cord
- ④ Two high voltage pistols (red and blue) with a 3 m cable.
- ⑤ Two right-angled safety cords (red and black), length 3 m.
- ⑥ Three extension connectors (green, yellow, blue)
- ⑦ Four test probes (black, red, green and blue).
- ⑧ Three crocodile clips (red, green, blue)
- ⑨ One Kelvin 25 A crocodile clip with a 2.5 m cable.
- ⑩ One carrying case.
- ⑪ A Kelvin 25 A pistol with a 3 m cable.
- ⑫ One tripod cord - 3 safety cords, length 2.5 m.
- ⑬ One tripod cord - Schuko, length 2.5 m.
- ⑭ One multilingual quick start guide.
- ⑮ One multilingual safety data sheet
- ⑯ One test report.

1.3. ACCESSORIES

- Pedal for foot control, with 10 m cable.
- 4-colour signal lamp tower with 5 m cable.
- Set of two high voltage pistols (red and blue) with a 15 m cable.
- Kelvin 25 A pistol with a 6 m cable.
- Label printer.
- 2D (QR code) barcode reader.
- Three-phase adapter - 16 A banana plugs.
- G72 clamp.
- RFID (Radio Frequency Identification) reader.
- Set of 100 125 kHz RFID tags.



1.4. SPARES

- Set of two high voltage pistols (red and blue) with a 3 m cable.
- Kelvin 25 A pistol with a 3 m cable.
- Sets of two 10 A Kelvin pistols with a 2.5 m cable.
- 25A Kelvin crocodile clip with 2.5m cable.
- Three extension connectors.
- Three crocodile clips (red, green and blue).
- Three test probes (red, green and blue).
- Two crocodile clips (red and black).
- Two test probes (red and black).
- Tripod cord - 3 safety cords.
- Tripod cord - Schuko.
- USB A/B cord.
- C19 power cord.
- Carrying case

For accessories and spares, check out our Web site:
www.chauvin-arnoux.com

1.5. CHOICE OF LANGUAGE

The language installed by default is that of the country where the instrument is shipped.

However, you can change this language. There are more than 15 languages available.

Press .

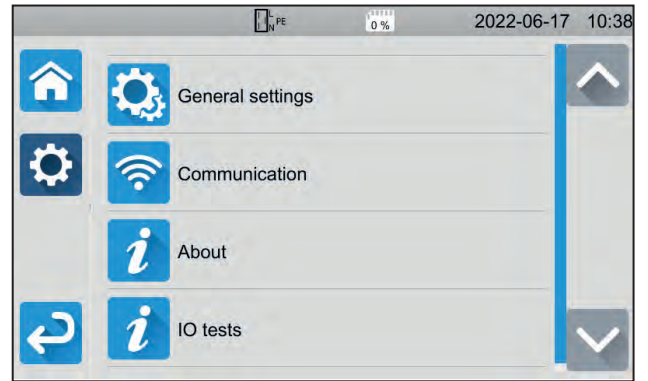
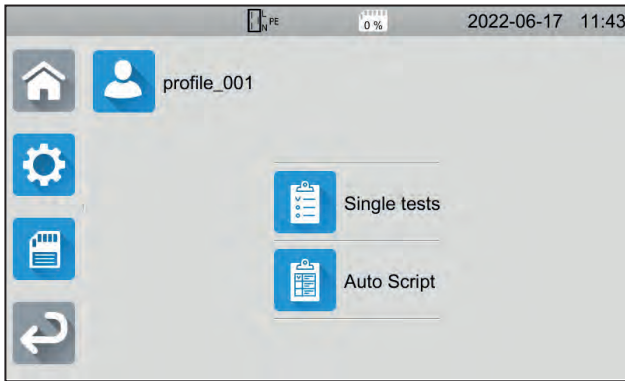



Figure 3

Press  then **Language**.

Select your language and confirm with .

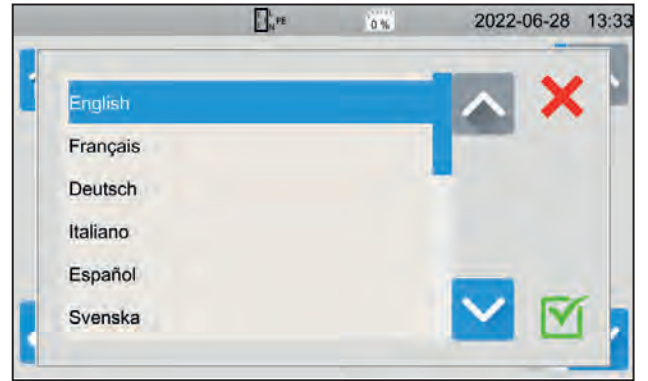
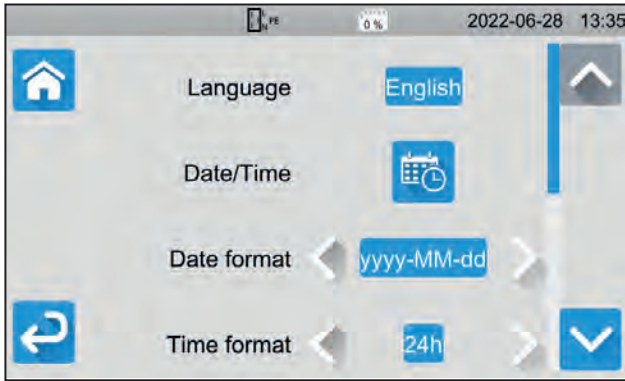

Figure 4

Press 2 times on  to go back to the main menu.

2. INSTRUMENT PRESENTATION

2.1. CA 6161

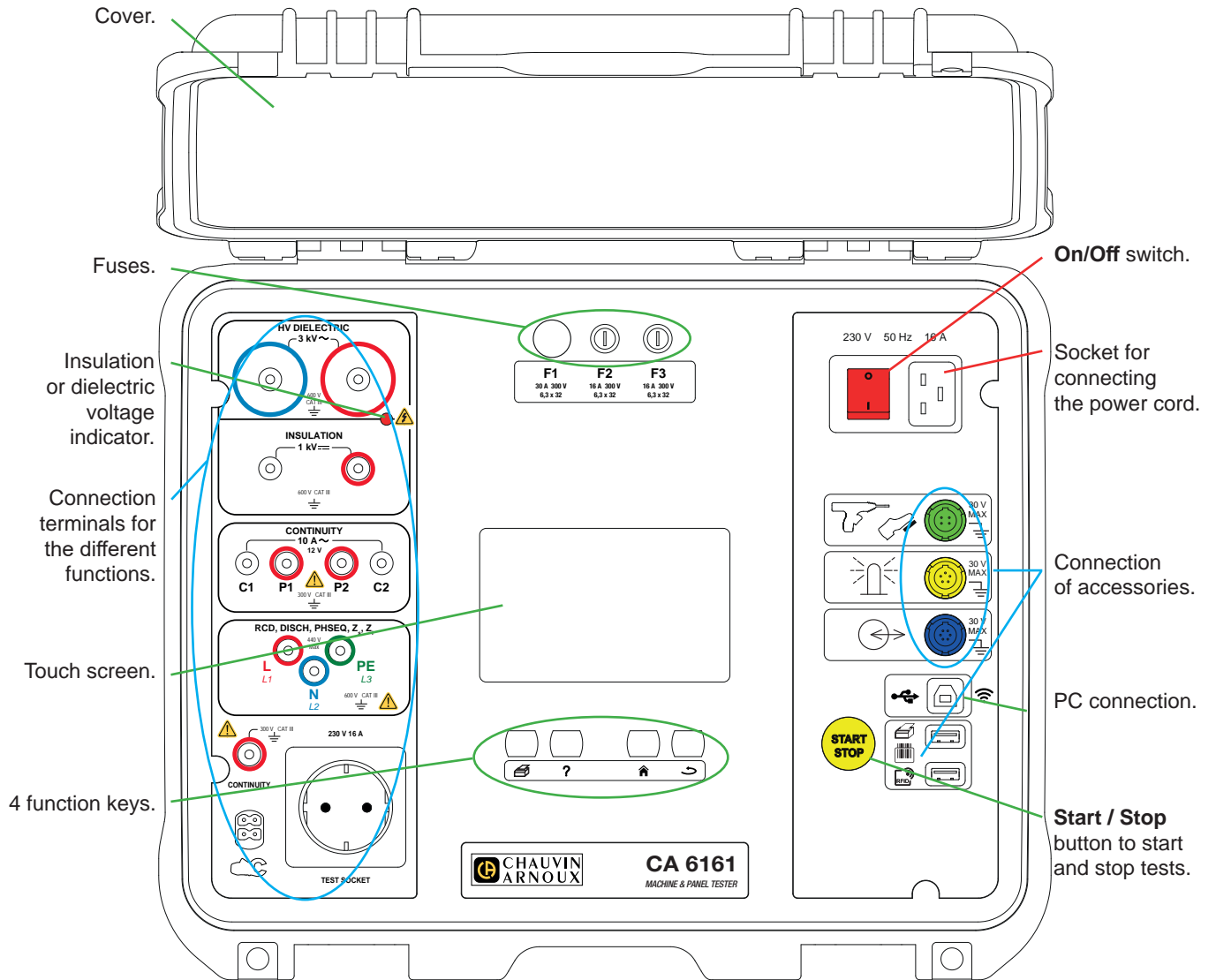

Figure 5

2.2. OPENING THE COVER

To open the cover, lower the latches and then lift the case closures.

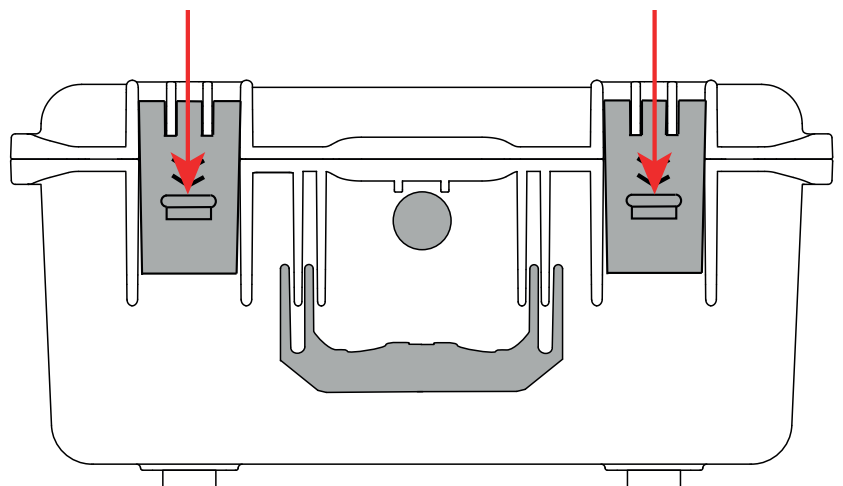

Figure 6

2.3. CA 6163

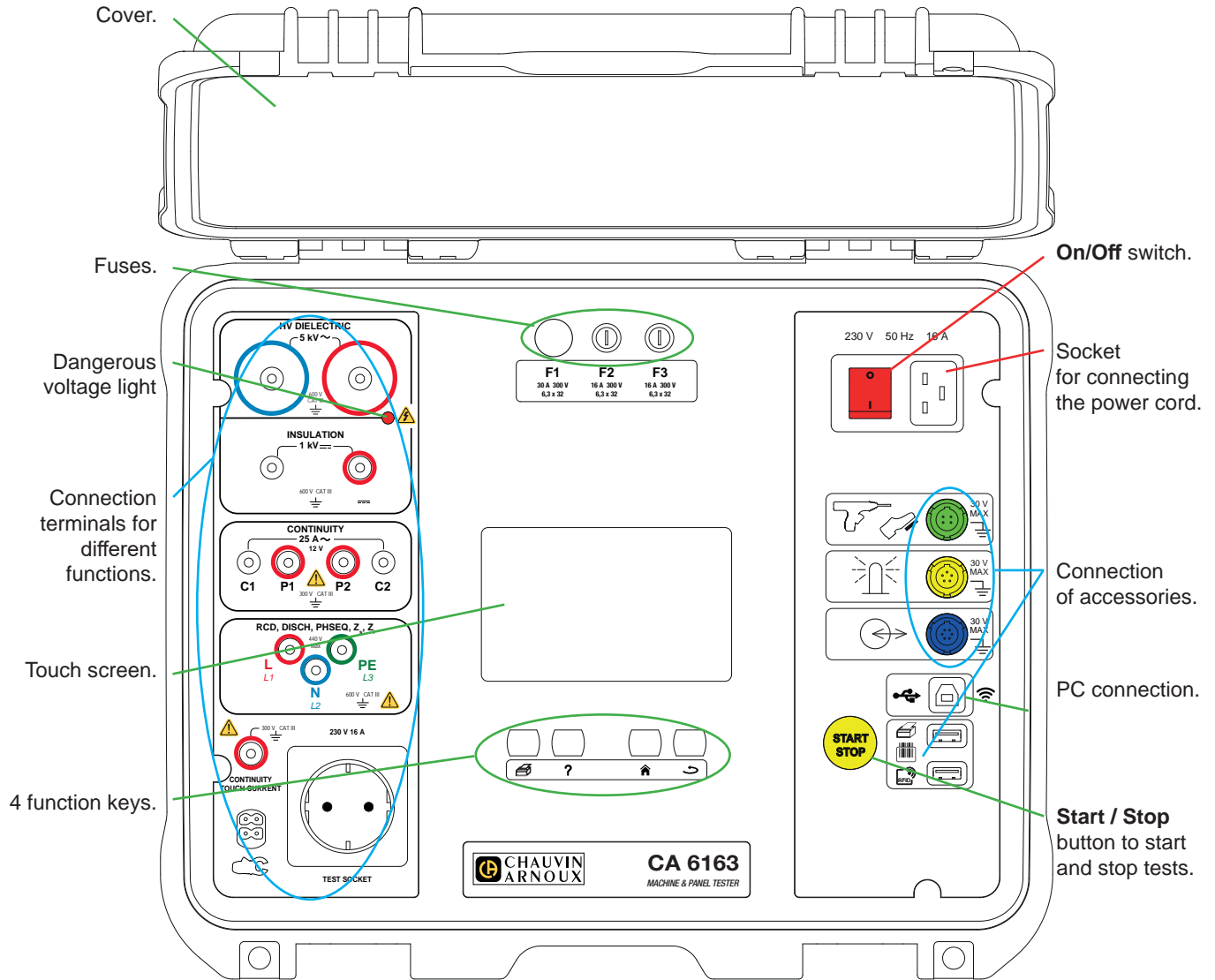





Figure 7

2.4. KEYS

-  To print a label for the current measurement or Auto Script.
-  To display help corresponding to the current function.
To calibrate the touch screen (long press).
-  To return to home.
-  To go up one level.

2.5. INSTRUMENT FEATURES

The CA 6161 and CA 6163 machine and panel controllers are portable measuring instruments with a colour resistive graphic touchscreen, powered by the mains.

These instruments are intended to check the electrical safety of portable electrical equipment, machines and electrical panels. They make it possible to check and certify a new device at the end of manufacturing, to periodically check that it is not dangerous for users or, during maintenance operations, to check it before authorising its use.

Machine and panel controllers make it possible to:

- make continuity measurements up to 100 mA, 200 mA and 10 A, and up to 25 A for the CA 6163 only,
- make insulation measurements up to 100 V, 250 V, 500 V and 1000 V,
- conduct a dielectric test (up to 3000 V for the CA 6161 and up to 5350 V for the CA 6163) with a fixed voltage or a voltage which gradually increases,
- test AC, A, B or F type circuit breakers or differential switches,
- make loop impedance measurements with or without tripping,
- make line impedance measurements,
- make power measurements (with or without the optional G72 current clamp),
- measure direct leakage currents, differential leakage currents or leakage currents by the substitution method (CA 6163) with the optional G72 current clamp,
- measure contact leakage currents (CA 6163),
- measure discharge time,
- know the direction of phase rotation on three-phase networks.

To ensure user safety, dielectric tests that generate dangerous voltage require entering a password.

The sound signal makes it possible to check that the measurements are correct without having to look at the display.

2.6. DISPLAY

The display is a colour graphic touch screen.

- Before the measurements, it allows displaying and modifying the parameters that will be used.
- After the measurement, it displays the result and indicates whether the measurement is valid or not.

Below is an example of a display:

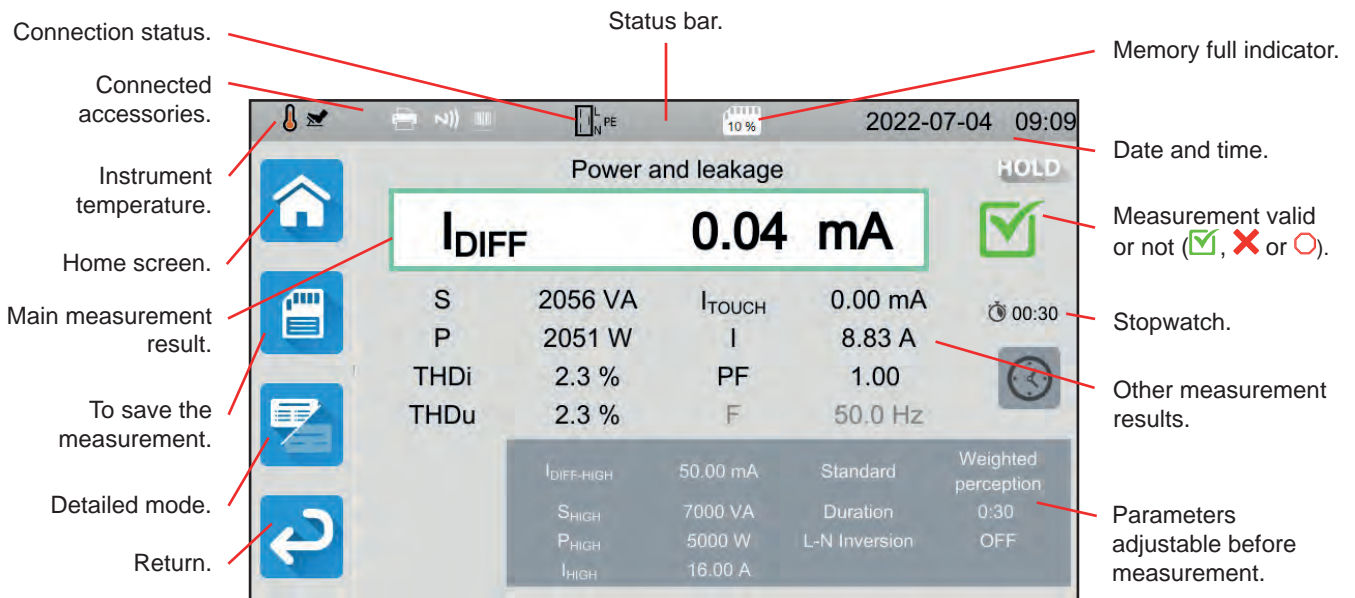

Figure 8

2.7. CONNECTORS

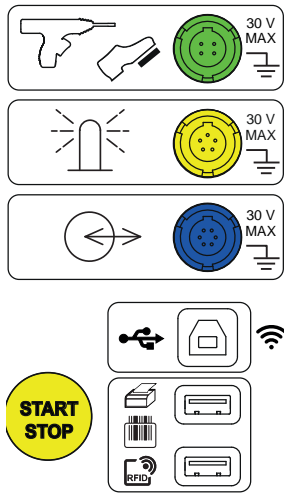

Figure 9

Specific green 4-point socket for connecting the dielectric pistol control or the foot control pedal (optional).

Specific yellow 5-point socket to connect the signal lamp tower (optional).

Specific blue 6-point socket for connecting the door closure checker.

USB type B socket to connect to a PC in order to be able to transfer recorded data or update firmware.

2 USB type A sockets to connect printer, barcode reader or RFID receiver.

2.8. TERMINALS

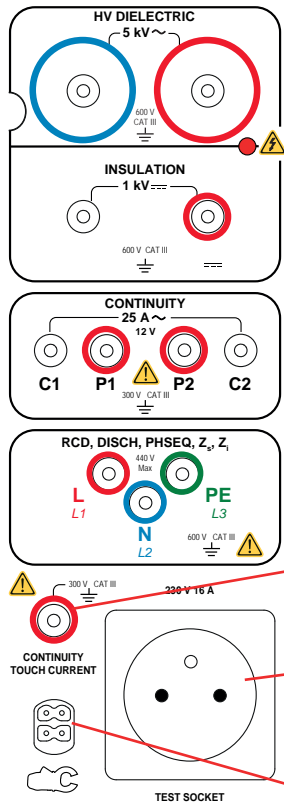

Figure 10

2 safety terminals to connect high voltage pistols for dielectric tests.

2 safety terminals for connecting safety leads for insulation measurements.

4 safety terminals for connecting Kelvin pistols and/or Kelvin crocodile clips for continuity measurements.

3 safety terminals to connect the tripod cord for measurements on the mains, in an electrical panel or in a control panel.

1 safety terminal to connect a safety lead for continuity measurements on terminals and contact current measurements (CA 6163).

1 Schuko socket to connect the power cord of the instrument to be tested for continuity, insulation, power or discharge time measurements. This plug can be replaced by a plug suitable for your country.

1 specific 4-point connector for connecting the current clamp (optional) for current measurements.

3. CONFIGURATION

3.1. GENERAL

When leaving the factory, the instrument is configured in such a way that it can be used without having to modify the parameters. For most measurements, you just need to select the measurement function and press the **Start / Stop** button.

However, you have the option to configure the instrument and the measurements.

3.1.1. CONFIGURATION

When configuring measurements, most of the time, you have the choice between:

- confirm by pressing ,
- or exit without saving by pressing  or the  key.

When confirming is not required, it is not possible to cancel. The configuration must be changed again.

3.1.2. HELP

In addition to an intuitive interface, the instrument offers maximum help with use.

- Help is accessed by the  key. It indicates the connection diagrams to be made for each function.
- Error messages appear when the **TEST** button is pressed, and sometimes before, to report connection errors, measurement configuration errors, measurement range overruns, defective installations tested, etc.

3.2. STARTING UP

Connect the mains lead between the instrument socket and the mains. The instrument can only operate on TT or TN networks (see § 11.2).



The power supply network must be protected by a differential circuit breaker in accordance with the electrical installation.

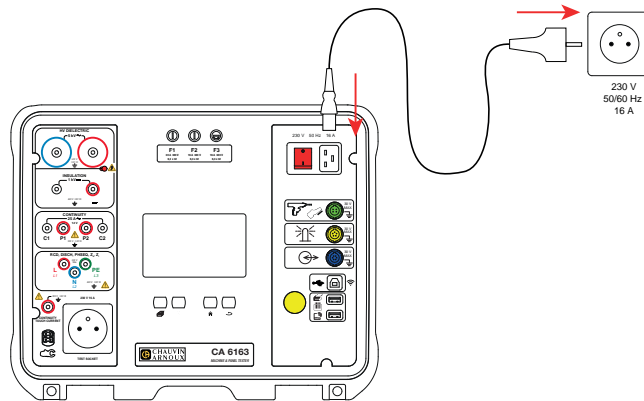

Figure 11



Press the **On / Off** switch. It lights up to indicate that the mains voltage is indeed present. The **Start / Stop** button also lights up. If the instrument does not start, check fuses F2 and F3 (see § 9.2).

At start-up, the instrument checks:

- that the mains voltage is correct, i.e. it is between 207 and 253 V,
- the frequency is correct, i.e. it is between 45 and 55 Hz,
- that the protective conductor (PE) is correctly connected.

If the voltage or frequency are not correct, the instrument signals this and measurements are not allowed.

If the PE is not connected or if the distribution network is an IT network, the instrument signals this but the measurements are still authorised.

If the phase and the neutral are reversed, the instrument indicates this but measurements are still authorised.

3.3. SCREEN CALIBRATION

At first start up, the instrument will ask you to calibrate the touch screen.

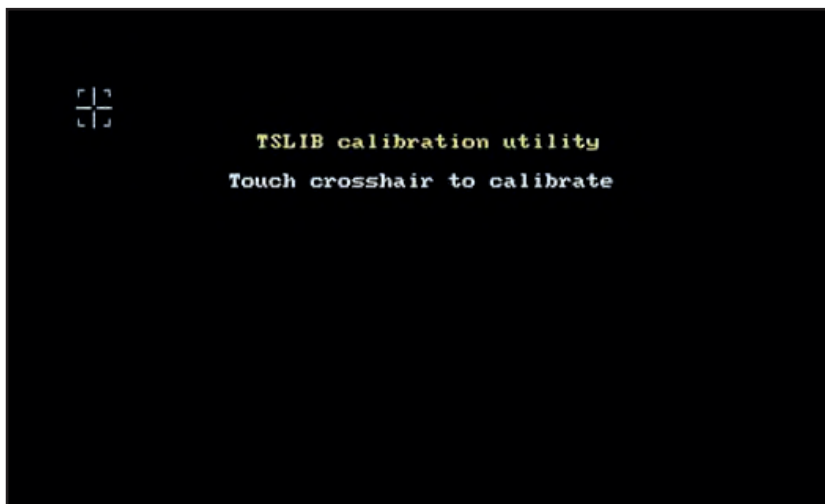



Figure 12

Press the target  when the instrument asks you to. The instrument then restarts to take the calibration into account.

When you want to recalibrate the screen, press and hold the help key .

3.4. USER PROFILES

The home screen is displayed:

Current user profile.

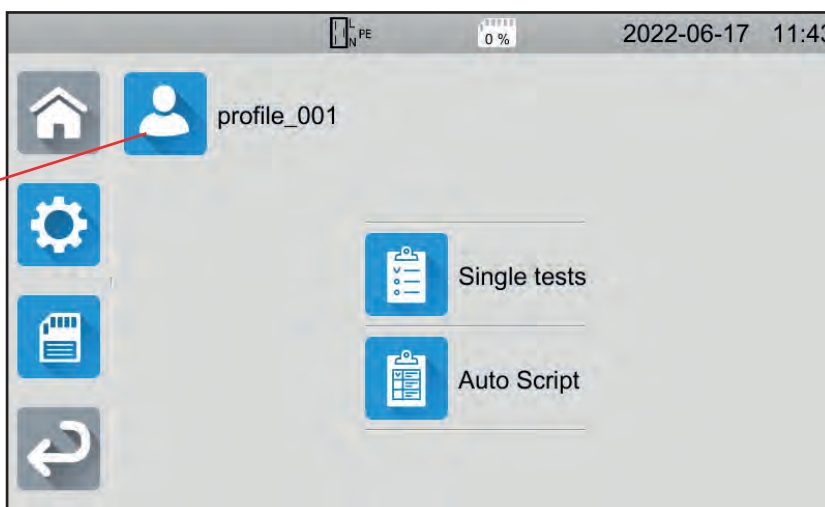



Figure 13

The instrument allows several user profiles to be managed. Press  to enter the user menu.

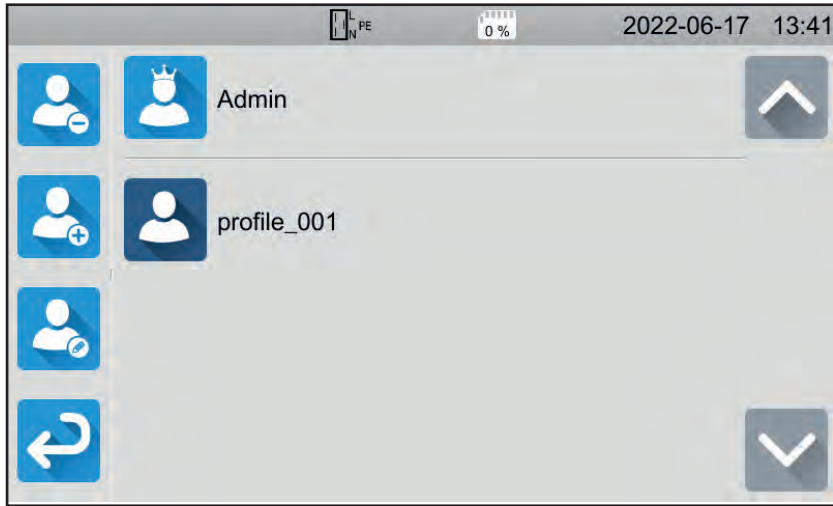





Figure 14

-  To delete a user. Only the administrator can do this and this action is protected by a non-modifiable password: admin@1234.
-  To create a new user.
-  To modify a user. Select the user to be modified before pressing this key.

On first use of the instrument, create your user profile. Then each time you restart the instrument, you will find your settings again.

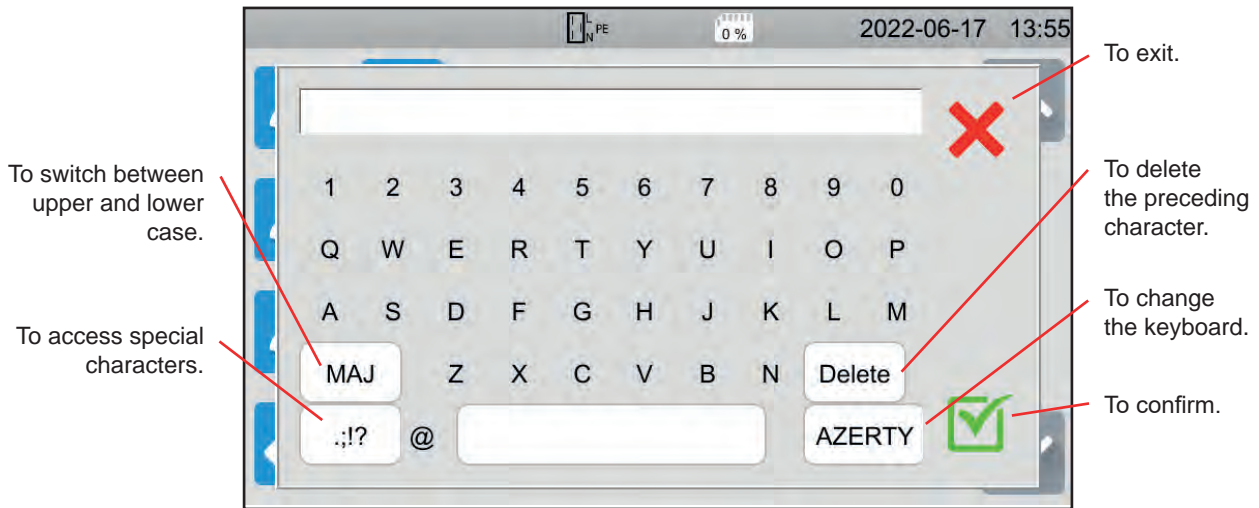

Figure 15

Multiple user profiles can be created. Each can have a different language.

The administrator profile (**Admin** password **admin@1234**) makes it possible to configure some specific functions such as the door checker and the password for performing dielectric tests.

3.5. CONFIGURING THE INSTRUMENT

Press  to enter setup.

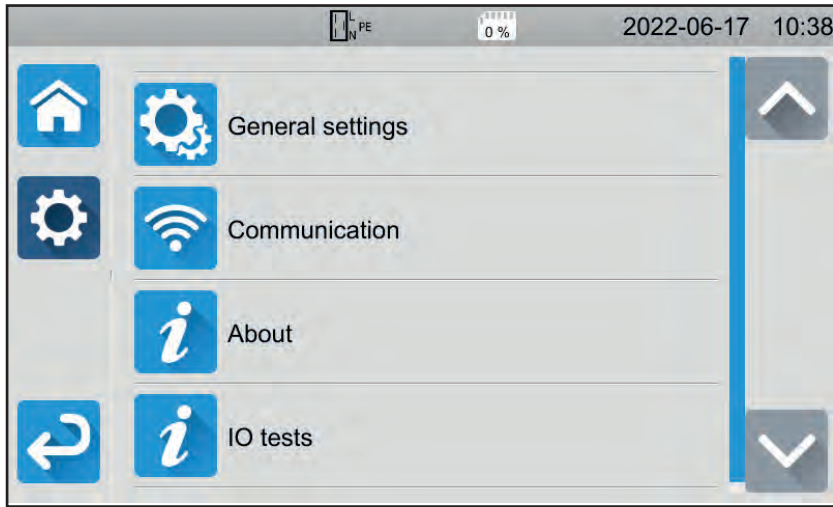

Figure 16



To enter the instrument's general configuration.

The general configuration makes it possible to:

- select the language,
- set the date and time as well as their formats,
- enable or disable the touch screen sound,
- enable or disable notifications, i.e. alarms,
- adjust screen brightness,
- indicate the status of the door checker for dielectric tests. Activation or deactivation is done in the administrator profile (see § 4.10.3).



To configure communication with the instrument:

- to connect to wifi,
- to indicate what accessories are connected.

To search for wifi networks.

To connect to the chosen wifi network.

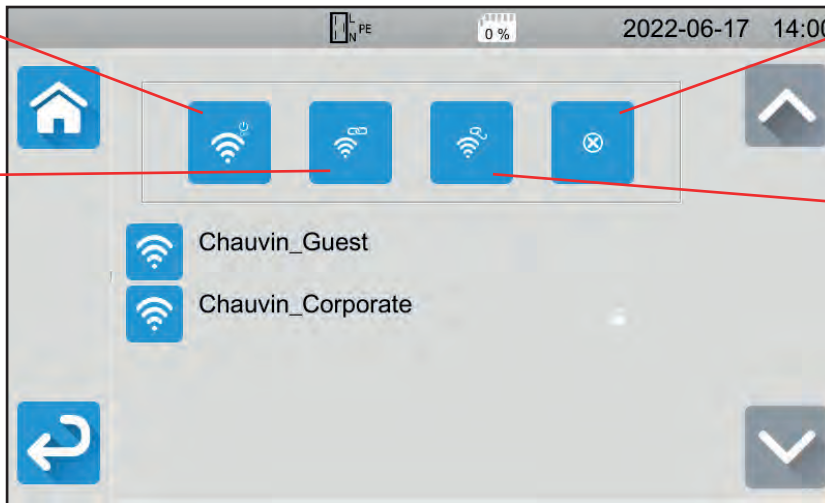

To forget the selected wifi network.

To disconnect from the selected wifi network.



Figure 17

Searching for wifi networks can take several minutes.



About

To display information about the instrument, including:

- model,
- firmware versions,
- wired card versions,
- serial number,
- wifi IP address,
- wifi mac address.



Peripherals test

To check for accessories plugged into the connectors:



- foot control pedal,
- signal lamp tower,
- door closed checker,

To check the operation of the **Start / Stop** button:

- green,
- red,
- off.

4. USE

4.1. KEYS

Also at any time, you can press the  key to return to home or the  key to move up a level.

During a measurement, you can press the  help key to help you with the connection.

4.2. VISUAL INSPECTION

Before carrying out tests on your machine, you must visually inspect it to verify that it does not present a hazard.

On the home screen, press **Unit tests**  , then **Visual inspections**  .

The following screen is displayed:

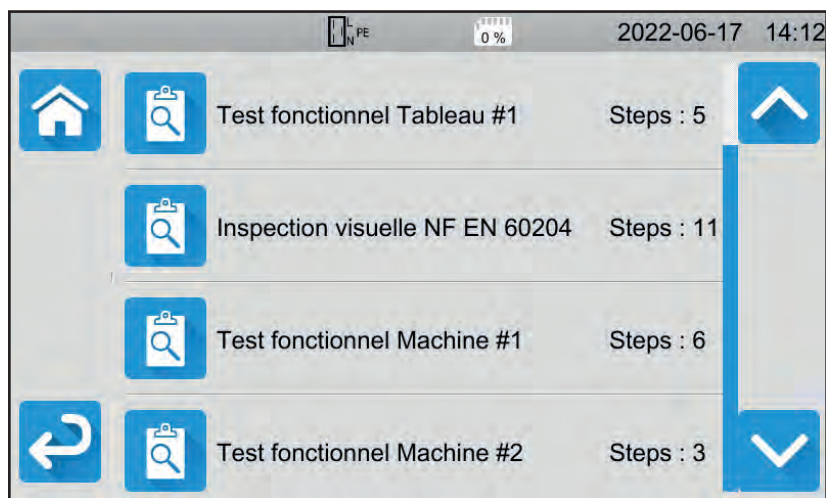



Figure 18

A visual inspection has a number of headings, each containing several sub-levels.

If you choose the first heading, the following screen is displayed:



Figure 19

For each heading and sub-level, visual inspection consists of indicating whether the test is passed , or not , or not applicable. Press the blue square until you get the desired value.

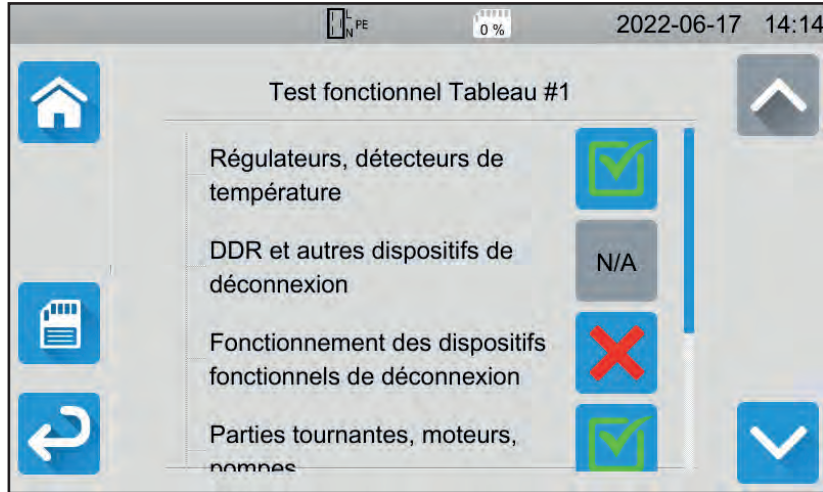

Figure 20

The overall status of the visual inspection is a logical function of whether or not the headings and sub-levels are validated.

Typical inspection libraries (according to EN 60204-1 or EN 61439-1) are present in the instrument. You can personalise them using the MTT application software.

4.3. SOUND SIGNAL



The sound signal tells you:

- that the measurement is valid,
- that the measurement is not valid,
- that the measurement has been interrupted,
- that the measurement is outside the measurement range,
- that the measurement has been saved,
- when measuring continuity, that the measurement is below the defined threshold.

4.4. INSTRUMENT TEMPERATURE



During continuity measurement, loop or line impedance measurement, differential test or dielectric test, the instrument can generate high currents. Its internal temperature then rises.

When the instrument is too hot to operate properly, it indicates this by displaying a symbol in the status bar.

- : The instrument temperature is high, but measurements are still possible.
- : the temperature of the instrument is too high and measurements are no longer possible.

4.5. CONNECTION

The status bar at the top of the display indicates the connection status of the instrument:

-  : L and N are not reversed and PE is connected.
-  : L and N reversed and PE connected.
-  : PE is disconnected. The L and N position cannot be determined.



For the instrument to work properly, the PE must be connected.

4.6. START / STOP BUTTON

You can only press the **Start / Stop** button when it is green.

If the button **Start / Stop** is blinking red, conditions do not allow the measurement to be made. Press the **Start / Stop** button and an error message will let you to correct your connection.

For example, to remove the voltages present for power-off measurements or to connect to the mains for live measurements. Once the problem has been corrected, the **Start / Stop** button turns green and you can start the measurement.



For certain measurements (insulation, dielectric), press and hold for several seconds.

During measurement, the **Start / Stop** button turns red then, at the end of the measurement, it turns off.



4.7. MEASUREMENT DURATION

For each measurement, you can define its stop criterion:

-  the measurement will last the time required for its completion.
-  the measurement will last for the time you have programmed.
-  the measurement duration is manual. You start and stop it by pressing the **Start / Stop** button.

4.8. CONTINUITY MEASUREMENT

The continuity measurement is made with the power off. It can be done with 2 or 4 wires. It is used to check the connection between the metal frame of the machine or all the accessible metal parts and the protective conductor (PE).

To comply with standard IEC 61557, measurements must be made at a minimum of 200 mA.

Press the **Unit tests**  icon then **Continuity** .

4.8.1. DESCRIPTION OF THE MEASURING PRINCIPLE

For continuity measurements, the instrument generates an alternating current at mains frequency between the terminals **C1** and **C2**. It then measures the voltage present between these two terminals and deduces the value of $R = V / I$. In the case of a 4-wire measurement, the voltage measurement is made between terminals **P1** and **P2**.

4.8.2. CONNECTION



Continuity measurements must be done with power off.

Connect the machine to be tested to the instrument. There are several options for this.

4.8.2.1. 2-wire continuity measurement

- Select the **External terminals** connection 
- Connect a safety lead between the terminal **C1** of the instrument and the protective conductor of the machine.
- Connect the other safety lead between the terminal **C2** of the instrument and the frame of the machine.

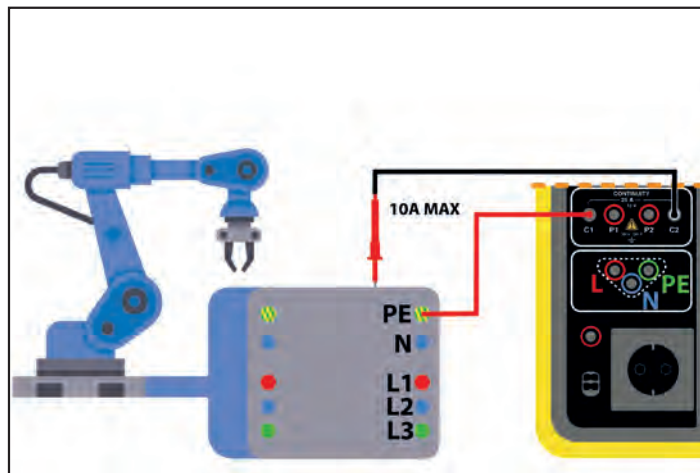

Figure 21

4.8.2.2. 4-wire continuity measurement

This measurement ensures better accuracy since the resistance of the leads is not included in the measurement.

- Select the **External Terminals**  connection.

For the CA 6161:

- Connect a double continuity cord to terminals **C1** and **P1** of the instrument and connect it to the protective conductor of the machine using 2 crocodile clips.
- Connect the other double continuity cord to terminals **C2** and **P2** of the instrument and connect it to the frame of the machine using 2 crocodile clips.

For the CA 6163:

- Connect a Kelvin crocodile clip to terminals **C1** and **P1** of the instrument and then connect it to the protective conductor of the machine.
- Connect a Kelvin pistol to terminals **C2** and **P2** of the instrument then maintain the contact on the frame of the machine.



Figure 22

4.8.2.3. Measurement via the test socket

If the machine has a Schuko type mains socket, you can use that of the instrument to connect the protective conductor. The measurement current cannot exceed 10 A.

- Select the **Test socket** connection .
- Connect the mains plug of the machine to the **TEST SOCKET** of the instrument.
- Connect a safety lead between the **CONTINUITY** terminal of the instrument and the frame of the machine.

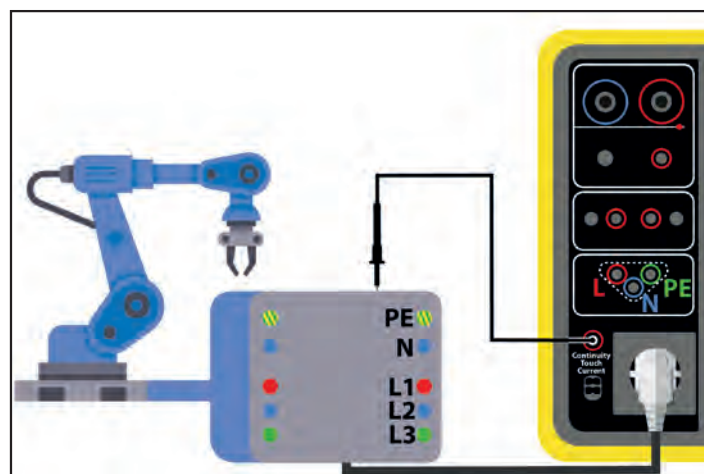

Figure 23

4.8.3. MEASUREMENT CONFIGURATION

The following screen is displayed:

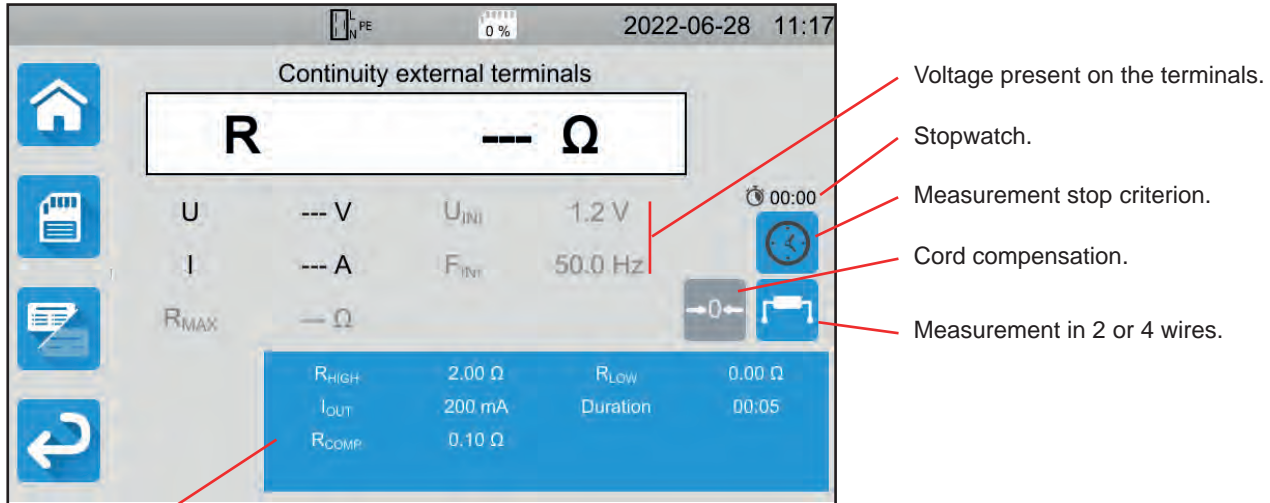



Figure 24

The parameters are in the blue rectangle. Press to modify them.

Shaded information is part of detailed mode. To remove them from the display, press  and the display will switch to simple mode .

In the case of continuity on the **test socket**, the following screen is displayed:

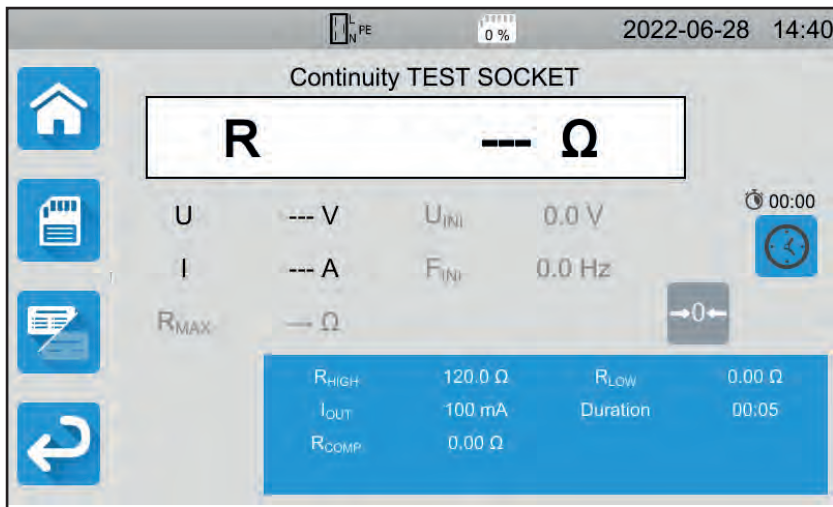

Figure 25

This is the same screen as for the **External terminals** connection but without the 2-wire / 4-wire choice.

- R_{HIGH} = maximum value of the continuity resistance. You can also choose MIN for the minimum value, MAX for the maximum value or OFF to give no upper limit. If the measurement is higher than R_{HIGH}, it will be declared invalid.

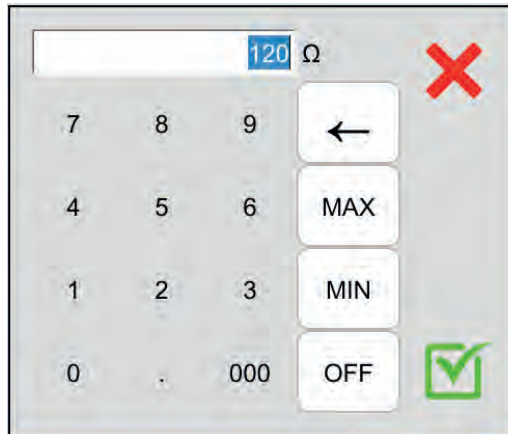



Figure 26

- R_{LOW} = minimum value of the continuity resistance. You can also choose MIN for the minimum value, MAX for the maximum value or OFF to give no lower limit. If the measurement is less than R_{LOW}, it will be declared invalid.
- I_{OUT} = measurement current value: 100 mA, 200 mA or 10 A, or 25 A (for the CA 6163 only, but not on the **TEST SOCKET** of the instrument). The high currents allow a very low continuity resistance measurement. The values of R_{HIGH} and R_{LOW} depend on the value of the measuring current.

Measurement current I _{OUT}	100 mA	200 mA	10 A	25 A (CA 6163)
R _{HIGH}	120.0 Ω	60.0 Ω	0.500 Ω	0.400 Ω
R _{LOW}	0.00 Ω	0.00 Ω	0.000 Ω	0.000 Ω

- 2-wire or 4-wire measurement



You can also make this choice by pressing the  or  symbol.

- ΔU TEST = only available for 4-wire measurements with a current of 10 A. This is the maximum value of the voltage as a function of the cable sectional area. You can activate it. The cable sectional area must then be entered.

Sectional are (mm ²)	0.5	0.75	1	1.5	2.5	4	≥ 6
ΔU test (V)	5.0	5.0	3.3	2.6	1.9	1.4	1.0

- Stop Criterion: The measurement stops either manually or at the end of the defined duration.

You can also make this choice by pressing the  symbol.

-  the measurement will last for the time you have programmed.
 -  the measurement duration is manual. You start and stop it by pressing the **Start / Stop** button.
- Duration: duration of the measurement in seconds in the case of a measurement with a programmed duration. You can also choose MIN for the minimum time, MAX for the maximum time or OFF for a manual measurement.
- R_{COMP} is used to compensate for the value of the resistance of the measurement leads, only for a 2-wire measurement or a measurement on the test socket. You can manually enter a value (between 0 and 5 Ω for currents of 100 or 200 mA and between 0 and 0.3 Ω for currents of 10 and 25 A) or measure the resistance of the leads and enter it into the instrument to apply it to all measurements.

4.8.4. CORD COMPENSATION

When measuring 2-wire continuity on the **external terminals** or when measuring on the **test socket**, to obtain a more precise measurement, you can subtract the resistance of the leads from the measurement.

- Short circuit the test leads according to one of the two diagrams below (depending on the connection).

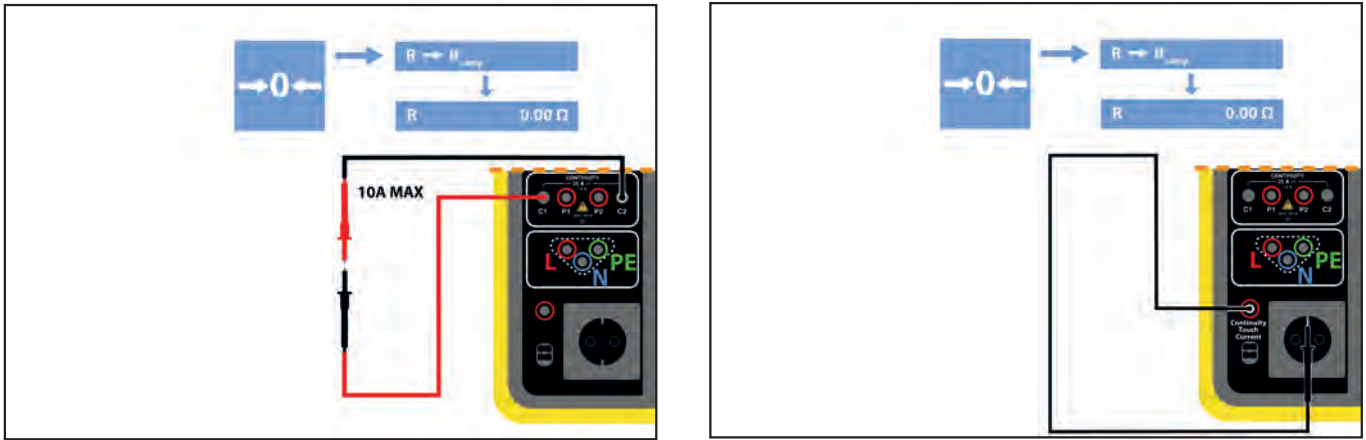



Figure 27

- Take a measurement by pressing the **Start / Stop** button.
- When the measurement is complete, press the  symbol. The measurement value is entered as the cord compensation value and the new value of RCOMP is displayed in the parameters rectangle.

4.8.5. PERFORMING A CONTINUITY MEASUREMENT

Before starting a measurement, make sure that the U_{INI} voltage is zero. Indeed, even a low voltage can distort the measurement. If a voltage of more than a few volts is present on the terminals, the instrument signals this and blocks the measurement.

Press the **Start / Stop** button to start the measurement.

You can only press the **Start / Stop** button when it is green. It turns red for the duration of the measurement then turns off.



If you have not chosen the automatic duration, wait until the measurement is stable then press the **Start / Stop** button again to stop it.

If you have chosen automatic duration, the stopwatch indicates the elapsed time.

4.8.6. READING THE RESULT

4.8.6.1. Example for a measurement with a current of 200 mA in 2 wires and in advanced mode

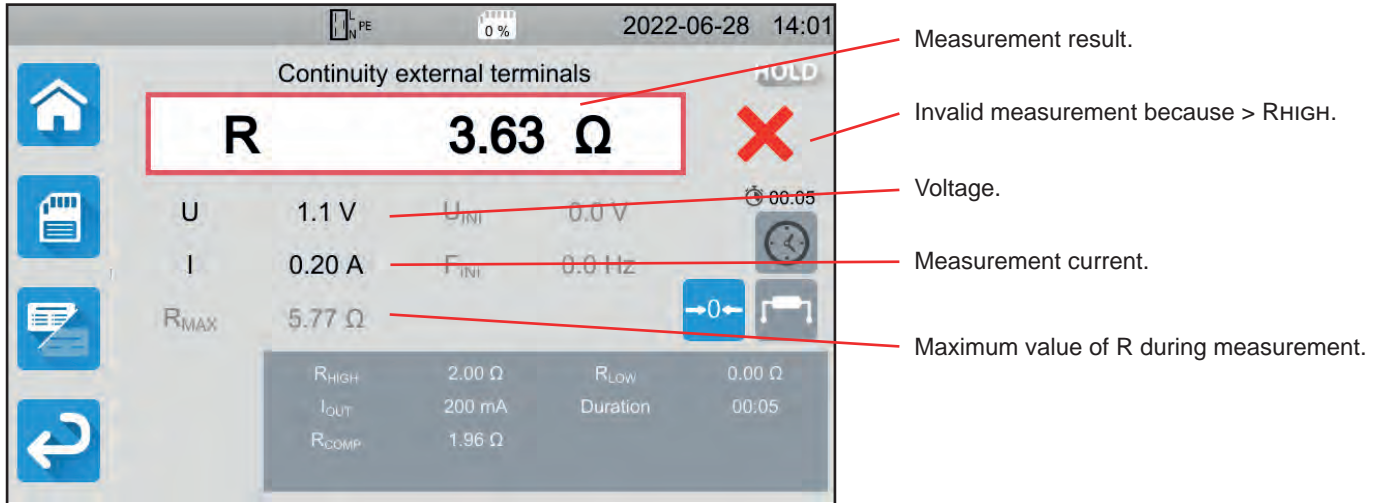

Figure 28

The measurement is not confirmed because it is higher than R_{HIGH}.

4.8.6.2. Example for a measurement with a current of 10 A in 4 wires and in normal mode

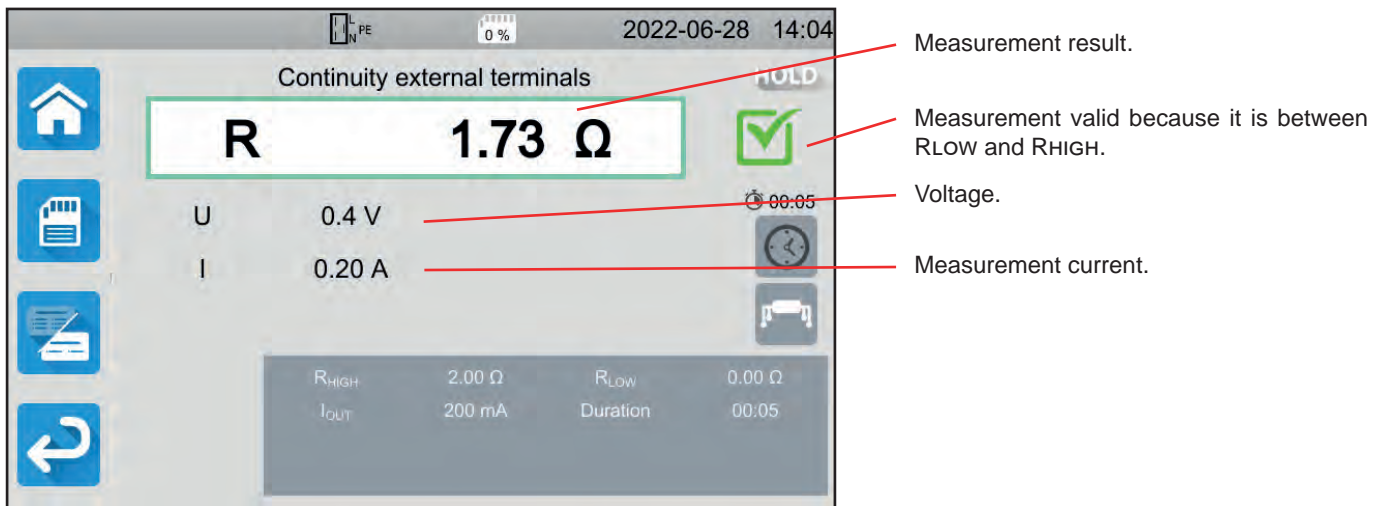
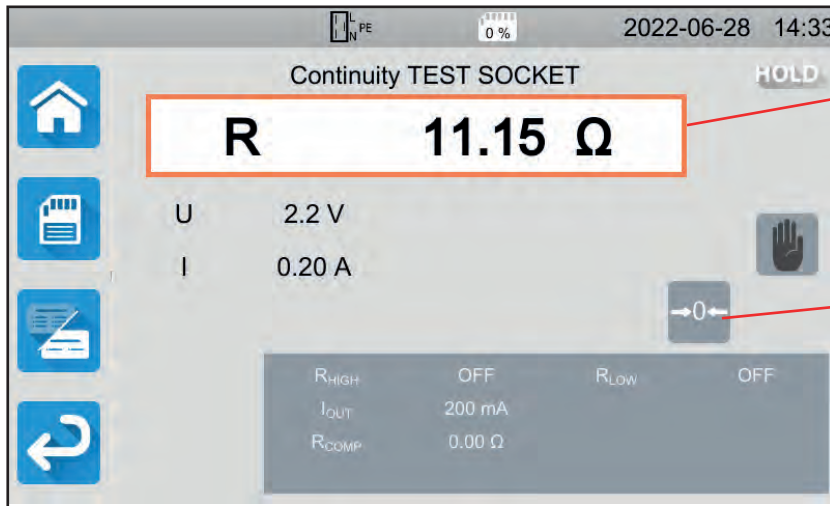

Figure 29

4.8.6.3. Example for a measurement on the test socket with a current of 100 mA without limit



When no limit has been set (R_{HIGH} and R_{LOW} are OFF), the measurement is neither valid nor invalid but just done. The box around the measurement is therefore neither green nor red, but orange.

When the measurement is $> 5 \Omega$, lead compensation is not possible.

Figure 30

You can save the measurement result by pressing .

If you have connected a printer to the instrument you can also print a label by pressing the  key.

To make a new measurement, press the **Start / Stop** button. It turns green.

4.8.7. ERROR INDICATION

The most common error for a continuity measurement is the presence of a voltage on the terminals. If a voltage higher than 5 V is detected, the **Start / Stop** button turns red. If you press it anyway, the instrument displays an error message. Remove the voltage, and repeat the measurement.

For measurements at 10 or 25 A, if the current is not generated, check fuse F1 (see § 9.2).

4.9. INSULATION MEASUREMENT RESISTANCE

Insulation measurement is done with power off. It is used to check the insulation resistance between conductors and accessible metal parts (earthed or insulated). This test reveals defects due to the ageing of materials.

This measurement, generally performed between short-circuited active conductors and earth, consists of applying a DC voltage, measuring the resulting current, and thus determining the value of the insulation resistance.

Press the **Unit tests**  icon then **Insulation** .

4.9.1. DESCRIPTION OF THE MEASURING PRINCIPLE

The instrument generates a DC test voltage between the **INSULATION** terminals. The value of this voltage depends on the resistance to be measured: it is greater than or equal to U_{NOM} when $R \geq U_{NOM} / 1 \text{ mA}$, and lower otherwise. The instrument measures the voltage and current present between the two terminals and deduces the value of $R = V / I$.

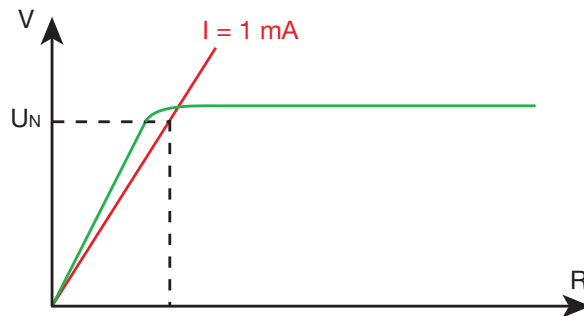



Figure 31

The red terminal is the reference point for the voltage.

4.9.2. CONNECTION

 Insulation measurements must be done with the power off.

Connect the machine to be tested to the instrument. There are several options for this.

4.9.2.1. Measurement of insulation on the external terminals

- Select the **External terminals** connection .
- Connect a safety lead between the black **INSULATION** terminal of the instrument and terminal N and all the phases of the machine connected together.
- Connect another safety lead between the red **INSULATION** terminal of the instrument and the frame of the machine.

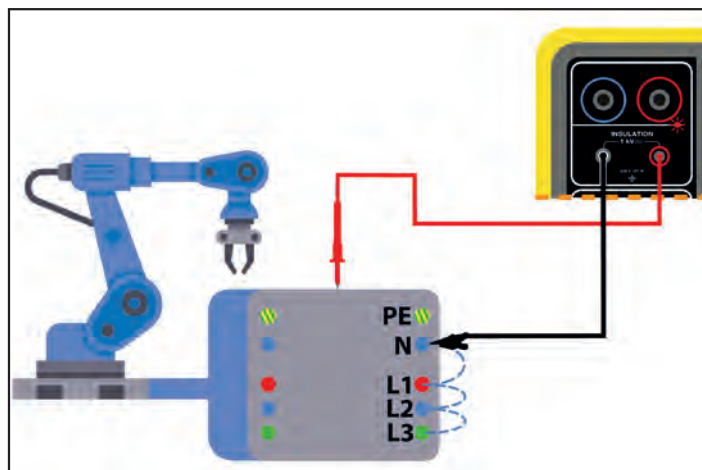

Figure 32

4.9.2.2. Measurement via the test socket



- Select the **Test socket** connection
- Connect the mains plug of the machine to the **TEST SOCKET** of the instrument. The measurement will be made between L and N connected together and PE.

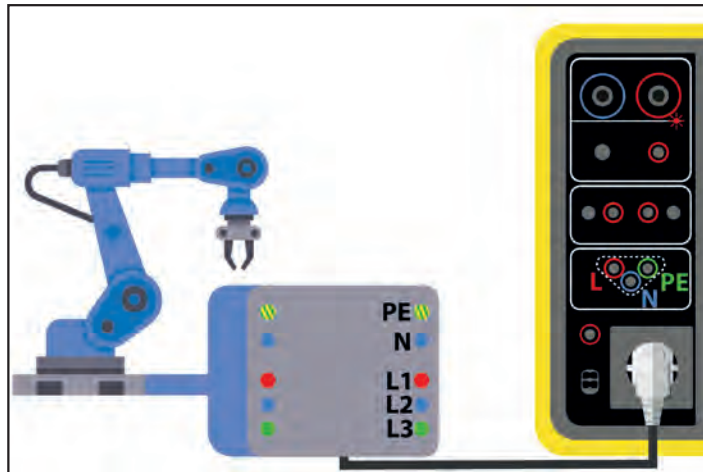
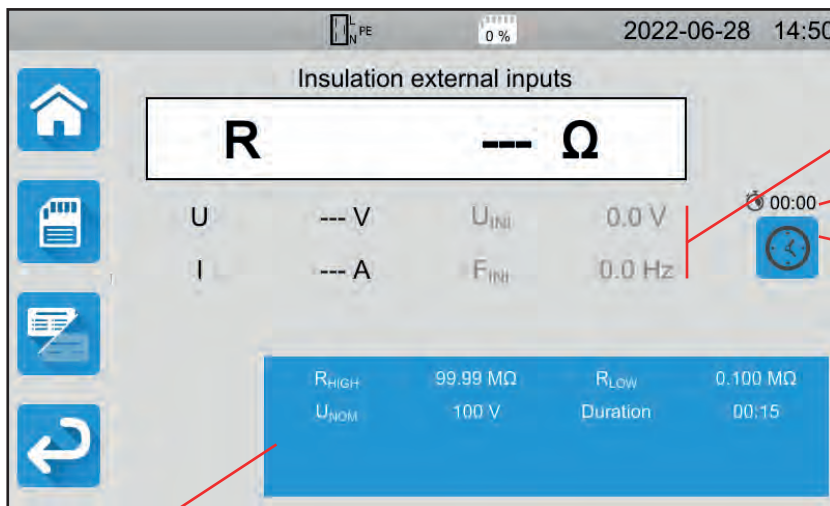

Figure 33

4.9.3. MEASUREMENT CONFIGURATION

The following screen is displayed:





Voltage present on the terminals.

Stopwatch.

Measurement stop criterion.

Figure 34



The parameters are in the blue rectangle. Press to modify them.

Shaded information is part of detailed mode. To remove them from the display, press  and the display will switch to simple mode .

- R_{HIGH} = maximum value of insulation resistance. You can also choose MIN for the minimum value, MAX for the maximum value or OFF to give no upper limit. If the measurement is higher than R_{HIGH}, it will be declared invalid.
- R_{LOW} = minimum value of insulation resistance. You can also choose MIN for the minimum value, MAX for the maximum value or OFF to give no lower limit. If the measurement is less than R_{LOW}, it will be declared invalid.
- U_{NOM} = value of the test voltage: 100 V, 250 V, 500 V or 1,000 V. The choice of test voltage depends on the value of the mains voltage of the network to which the machine is connected.

- Stop Criterion: The measurement stops either manually or at the end of the defined duration.

You can also make this choice by pressing the  symbol.

-  the measurement will last the time required for its completion.
 -  the measurement will last for the time you have programmed.
 -  the measurement duration is manual. You start and stop it by pressing the **Start / Stop** button.
- Duration: duration of the measurement in seconds in the case of a measurement with a programmed duration. You can also choose MIN for the minimum time, MAX for the maximum time.

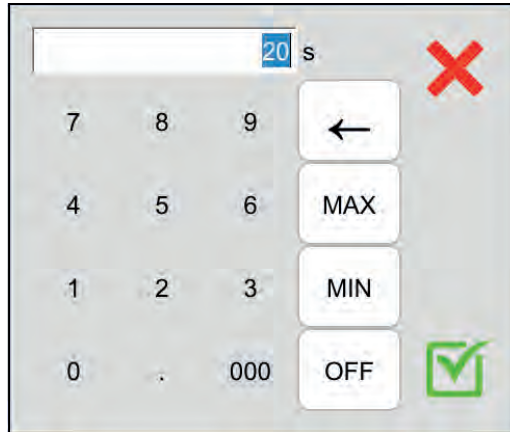



Figure 35

4.9.4. PERFORMING AN INSULATION MEASUREMENT

Before starting a measurement, make sure that the U_{INI} voltage is zero. If a voltage of more than 90 V is present on the terminals, the instrument signals this and blocks the measurement.

You can only press the **Start / Stop** button when it is green.

As soon as the test voltage is generated, the  indicator lights up.

Press the **Start / Stop** button to start the measurement and keep it pressed until it turns red, then you can release it. At the end of the measurement, it turns off.



If you have chosen manual mode, wait until the measurement is stable then press the **Start / Stop** button again to stop it.

During measurement, the stopwatch indicates the elapsed time.

4.9.5. READING THE RESULT

4.9.5.1. Example of a measurement with a test voltage of 500 V and in advanced mode

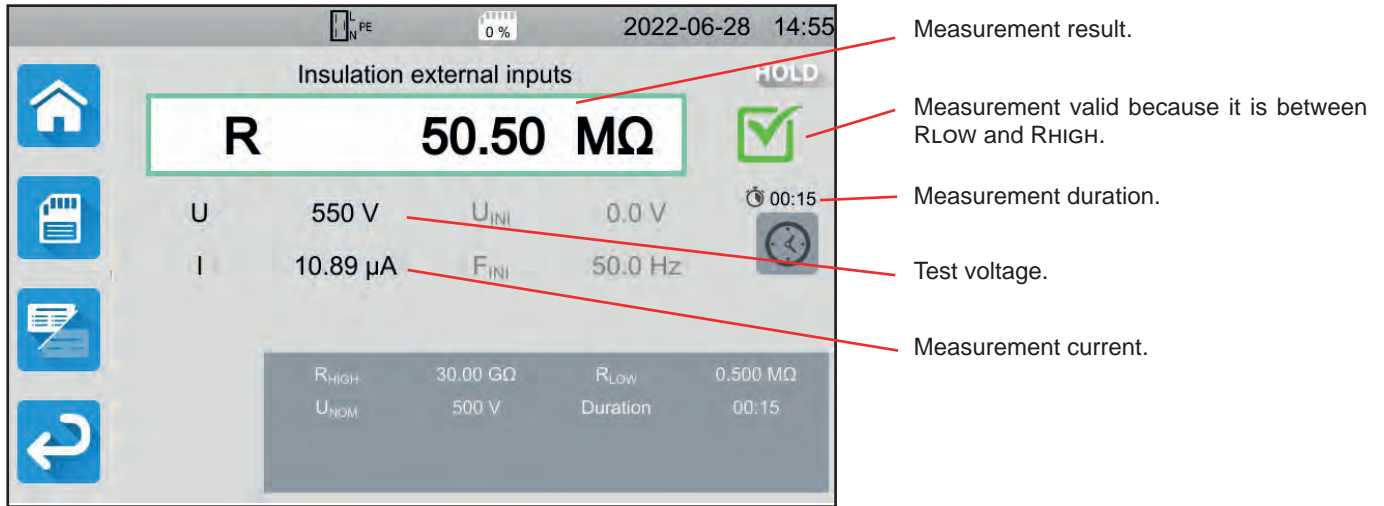

Figure 36

4.9.5.2. Example of a measurement with a test voltage of 1000 V and in normal mode

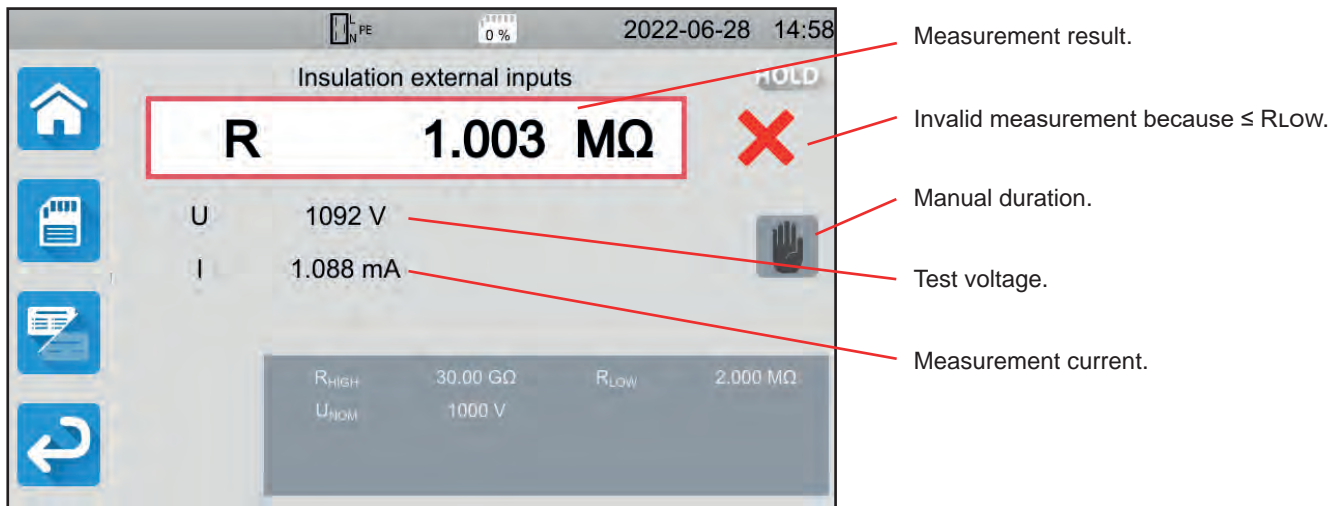



Figure 37

You can save the measurement result by pressing .

If you have connected a printer to the instrument you can also print a label by pressing the  key.

To make a new measurement, press the **Start / Stop** button. It turns green.



Before disconnecting the leads or starting another measurement, wait a few seconds for the instrument to discharge the machine being tested.

If the load is highly capacitive, you can see the voltage U decay. When it drops below 25 V, U takes on the value of the test voltage.

4.9.6. ERROR INDICATION

The most common error in the case of an insulation measurement is the presence of a voltage on the terminals. If it is higher than 90 V, the insulation measurement is not authorised. Remove the voltage, and repeat the measurement.

4.10. DIELECTRIC TEST

A dielectric test between two conductive parts makes it possible to check the dielectric strength. It ensures that in the event of a fault on the electrical network, for example a surge voltage due to lightning, the two conductive parts will remain insulated and will not cause a short circuit.

The test is generally done between 2 windings of a transformer, between the power supply and the frame of the machine or on the feeds of an electrical panel.



This measurement is dangerous. If the precautions for use are not respected, it can cause electric shock.



To ensure safety, the machine being tested must be marked out.



The test can be destructive for the equipment in the event of a defect.

There are 2 possible dielectric tests:

- the fixed voltage dielectric test
- the ramp voltage dielectric test.

Their difference lies in the form of the voltage generated. For the ramp voltage dielectric test, you can choose the slope of the rising voltage and the slope of the falling voltage. While in the fixed mode these slopes are fixed.

Press the **Unit tests** icon  then **Fixed voltage dielectric**  or **Ramp voltage dielectric** .

4.10.1. CONNECTION



Dielectric tests must be performed with the power off.

- Connect the blue high voltage pistol to the blue **HV DIELECTRIC** terminal of the instrument and place its tip on terminal N and all the phases of the machine connected together.
- Connect the red high voltage pistol to the red **HV DIELECTRIC** terminal of the instrument and on the frame of the machine.

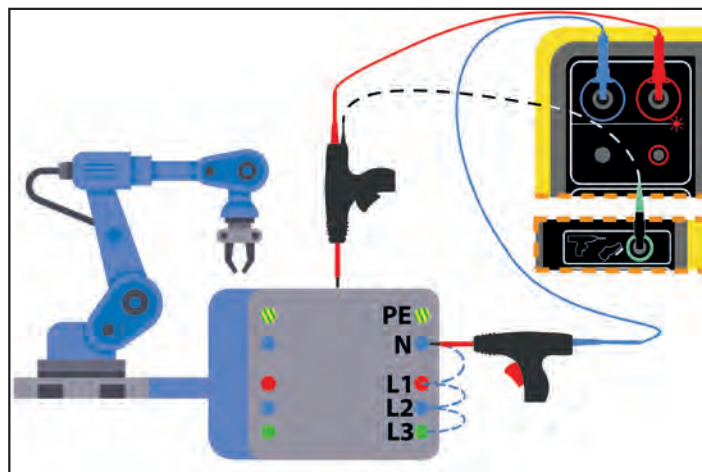

Figure 38

In the case of a transformer, place each high voltage pistol on one winding of the transformer.

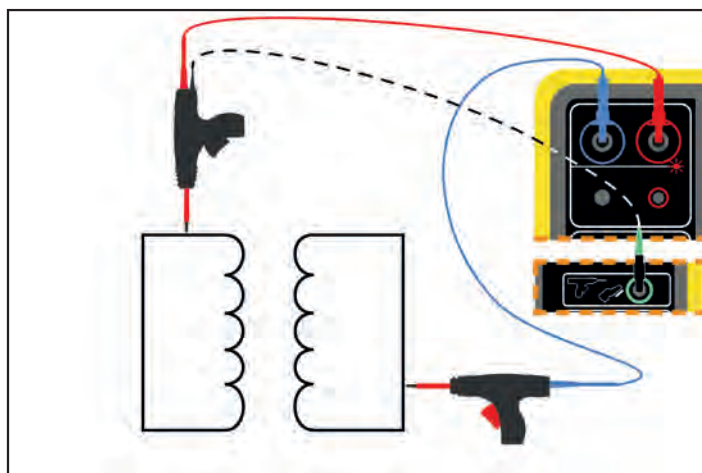

Figure 39

During the measurement, you will have to press the triggers of the 2 pistols to release their tips. So you no longer have a hand available to press the **Start / Stop** button on the instrument.

Then connect the black cord of the red pistol to the green connector of the instrument. In this way, the measurement will be triggered when you press the trigger. The **Start / Stop** button will be inactive.



To unlock the trigger of the high-voltage pistol, press down.

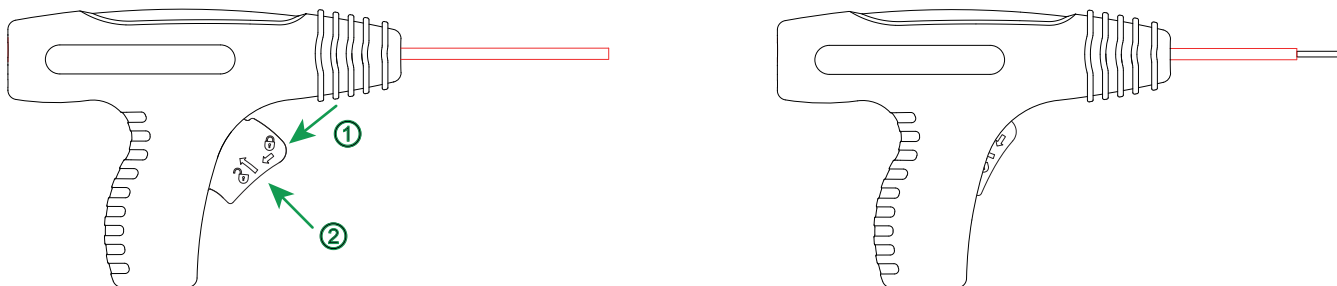

Figure 40

4.10.2. MEASUREMENT CONFIGURATION

4.10.2.1. Dielectric with fixed voltage

The following screen is displayed:

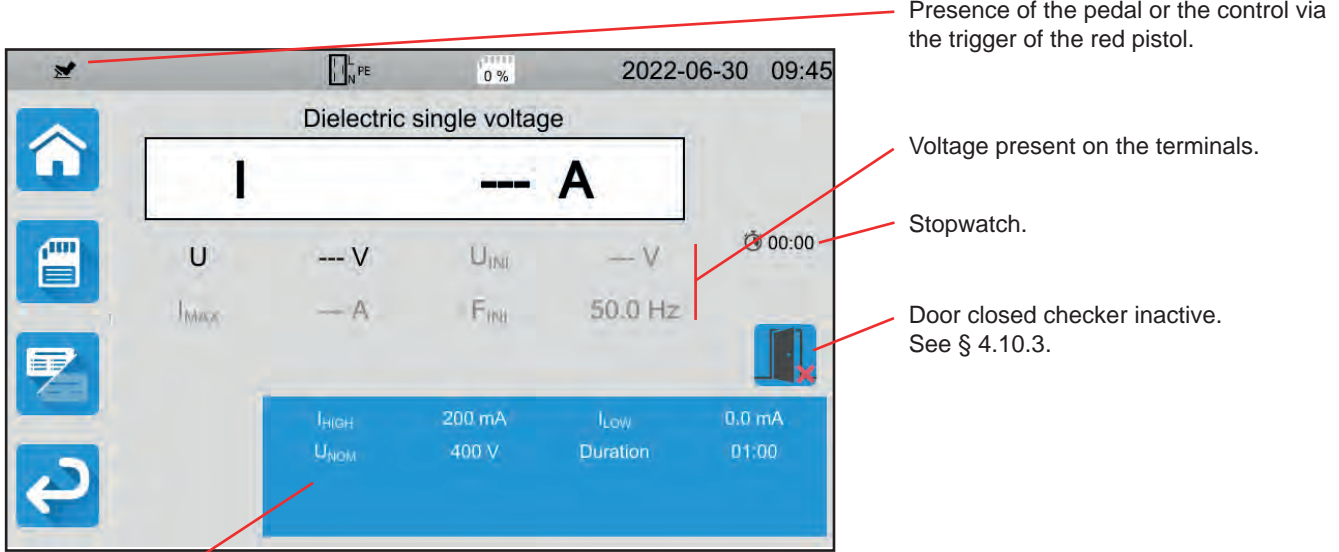



Figure 41

The parameters are in the blue rectangle. Press to modify them.

Shaded information is part of detailed mode. To remove them from the display, press  and the display will switch to simple mode .

- I_{HIGH} = maximum value of the dielectric current. You can also choose MIN for the minimum value, MAX for the maximum value or OFF to give no upper limit. If the measurement is higher than I_{HIGH} , it will be declared invalid.
- I_{LOW} = minimum value of the dielectric current. You can also choose MIN for the minimum value, MAX for the maximum value or OFF to give no lower limit. If the measurement is less than I_{LOW} , it will be declared invalid.
- U_{NOM} = test voltage value: between 40 and 3,000 V for the CA 6161 and 5,350 V for the CA 6163.
- Duration: duration of the measurement in seconds in the case of a measurement with a programmed duration. You can also choose MIN for the minimum time, MAX for the maximum time. It can range from 1 to 180 s.

The voltage follows the following curve:

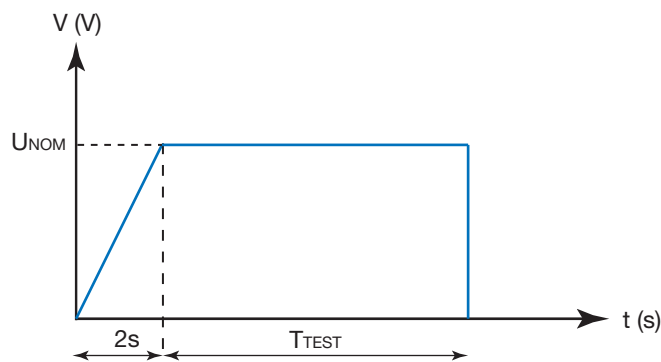

Figure 42

4.10.2.2. Dielectric with ramp

The following screen is displayed:

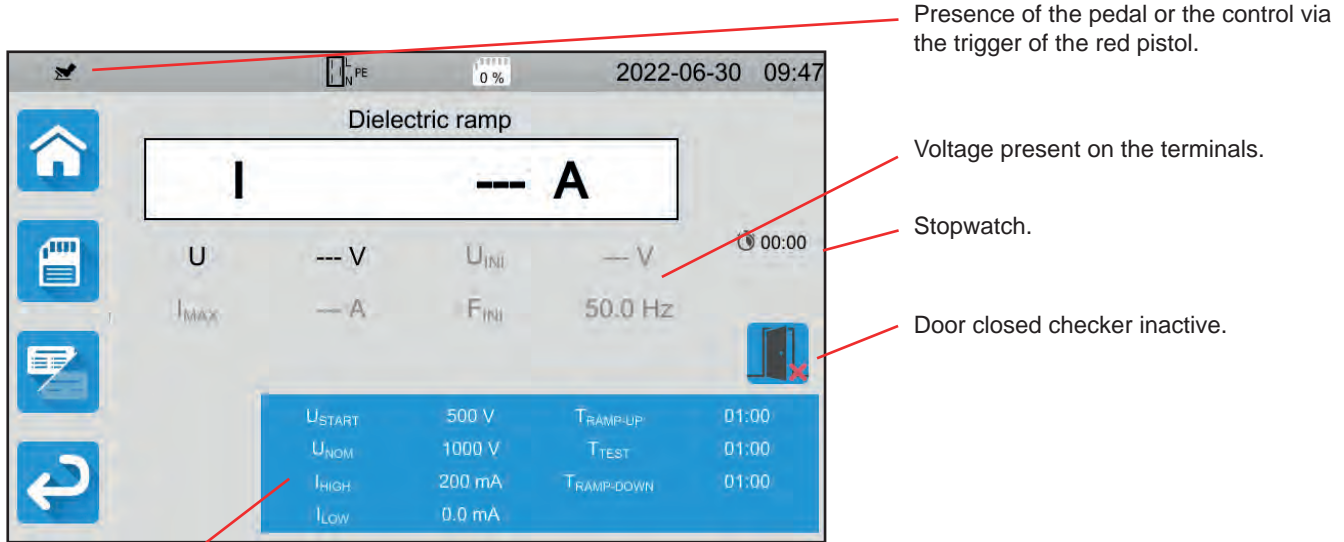



Figure 43

The parameters are in the blue rectangle. Press to modify them.

Shaded information is part of detailed mode. To remove them from the display, press  and the display will switch to simple mode .

- U_{START} = value of the voltage from which the increasing voltage ramp begins. It must be less than U_{NOM} . You can also choose MIN for the minimum value, MAX for the maximum value or OFF.

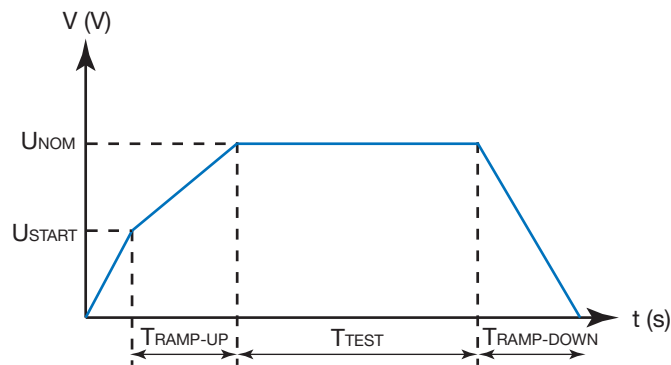

Figure 44

- U_{NOM} = test voltage value: between 40 and 3,750 V for the CA 6161 and 5,350 V for the CA 6163.
- TRAMP UP = duration of the voltage rise between U_{START} and U_{NOM} . It can range from 1 to 60 seconds.
- TTEST = time during which voltage U_{NOM} is applied. It can range from 1 to 180 seconds.
- TRAMP DOWN = duration of falling voltage between U_{NOM} and 0. It can range from 1 to 60 seconds.
- I_{HIGH} = maximum value of dielectric current. You can also choose MIN for the minimum value, MAX for the maximum value or OFF to give no upper limit. If the measurement is higher than I_{HIGH} , it will be declared invalid.
- I_{LOW} = minimum value of the dielectric current. You can also choose MIN for the minimum value, MAX for the maximum value or OFF to give no lower limit. If the measurement is less than I_{LOW} , it will be declared invalid.

4.10.3. DOOR CLOSED CHECKER,

By default the door closed checker is disabled. To activate it, follow the following procedure:

- Go to the home screen  then in user profiles .

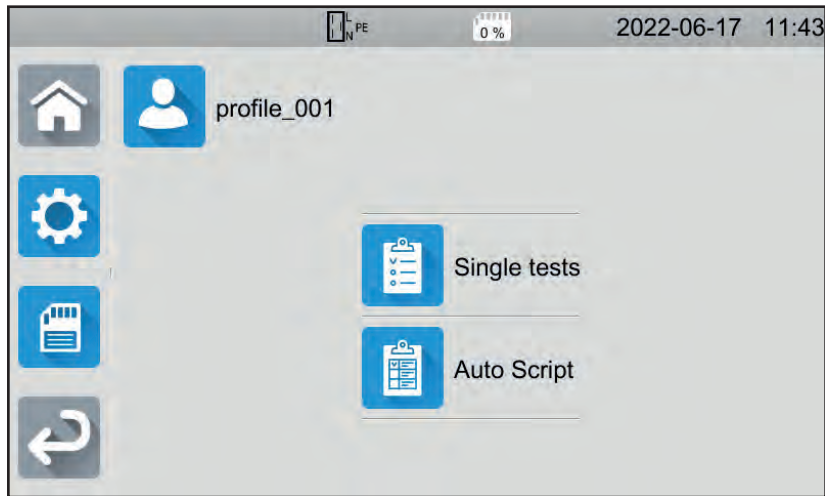

Figure 45



- Select the **Admin** profile. The instrument asks you to enter the password: **admin@1234**. The password is case sensitive!
- Then go to the configuration menu , then in the **general settings** .
- You can activate the door checker function and change the password for dielectric tests



Figure 46

- Then go back to your user profile.

When you enter dielectric tests, the door checker is active.

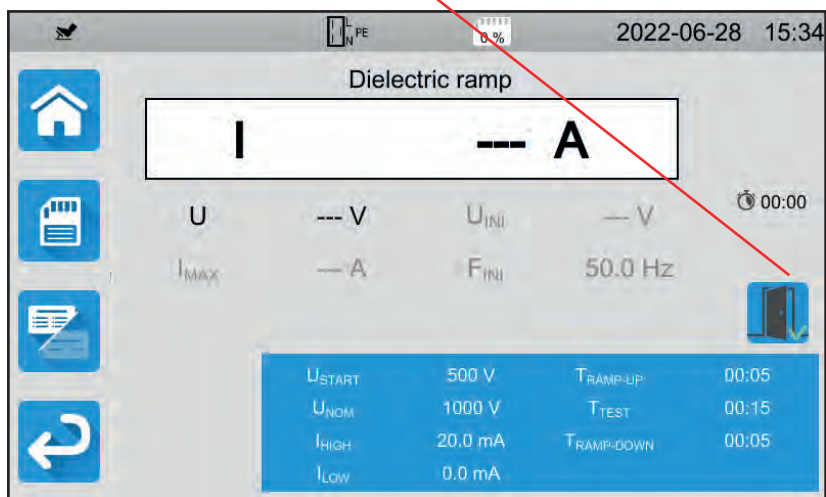



Figure 47

- Plug the door checker into the blue  connector.
- If the door is not closed when you start the test, the instrument notifies you and the test is impossible:

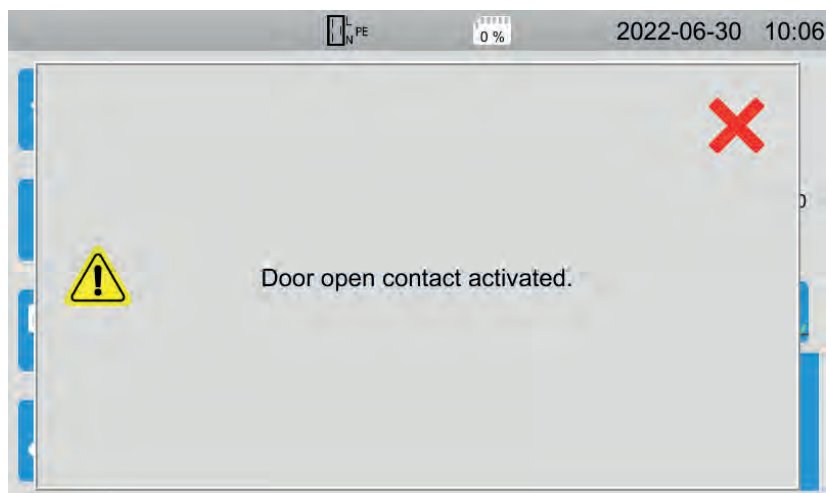

Figure 48

4.10.4. PERFORMING A DIELECTRIC TEST

Before starting a measurement, make sure that the UINI voltage is zero. If a voltage of more than 90 V is present on the terminals, the instrument signals this and blocks the measurement.

 During the dielectric test, both hands must be on the high voltage pistons.

You can only start the measurement, by pressing the trigger of the red pistol, when the **Start / Stop** button is green. Keep pressing until the **Start / Stop** button turns red,

For the first measurement, the instrument asks you for a password:

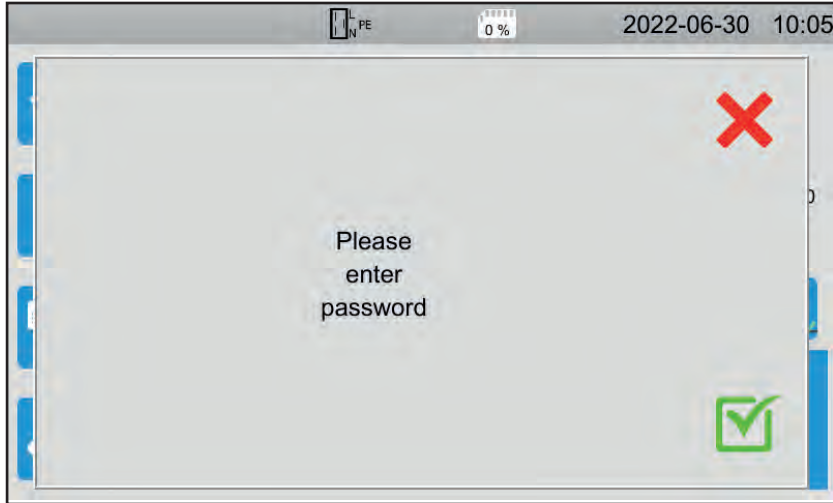



Figure 49

Press  then enter **hv@1234** or the password you set (see § 4.10.3). The password is case sensitive! Press the trigger again to start the measurement.

As soon as the test voltage is generated, the  indicator lights up.



During measurement, the stopwatch indicates the elapsed time. When the measurement is complete, the **Start / Stop** button turns off. You can see the voltage value gradually rise, stabilise, and then gradually fall to zero, following the curve of the fixed dielectric voltage or the ramp dielectric voltage.

4.10.5. READING THE RESULT

4.10.5.1. Example for a fixed voltage dielectric test with a voltage of 1000 V

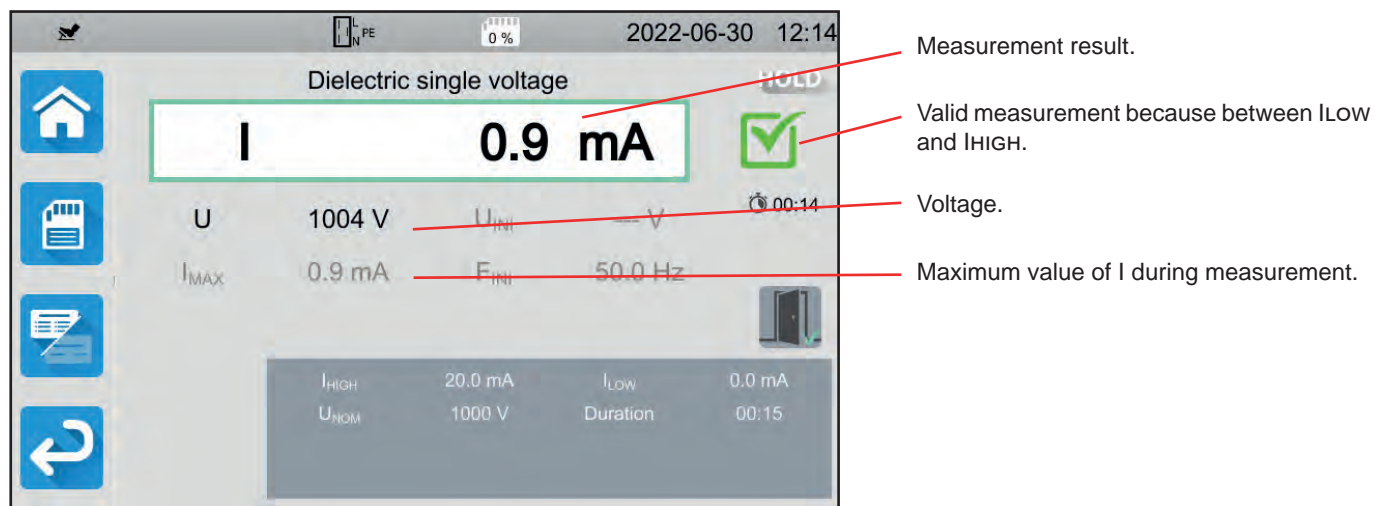

Figure 50

4.10.5.2. Example of a fixed voltage dielectric test with a voltage of 400 V stopped before the end of the programmed duration

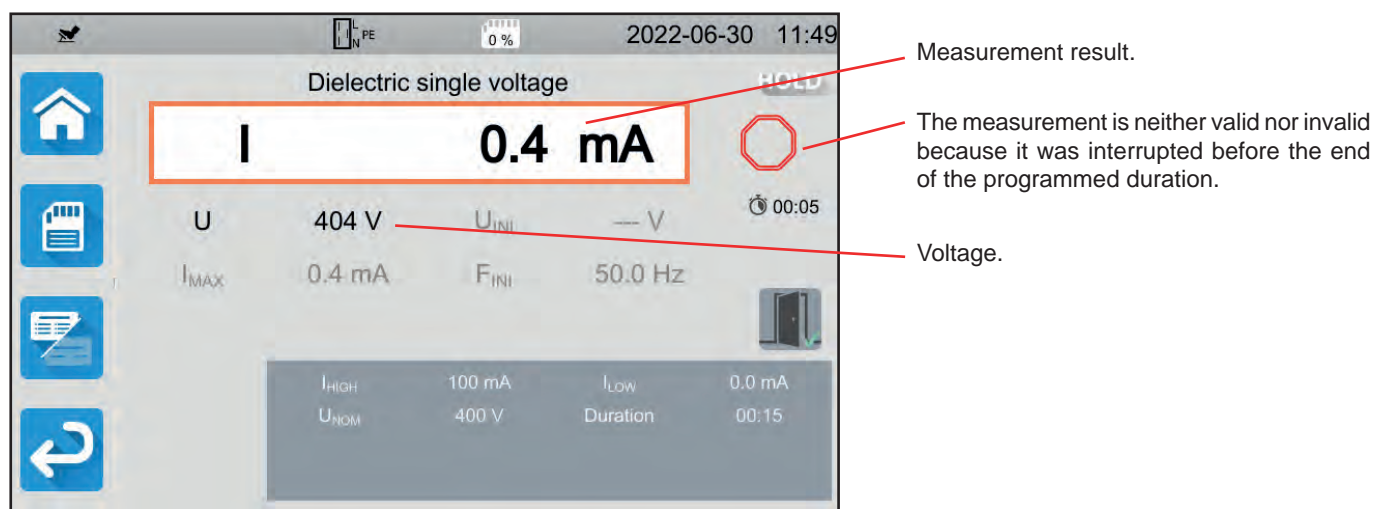

Figure 51

4.10.5.3. Example for a dielectric ramp test with a voltage of 1000 V

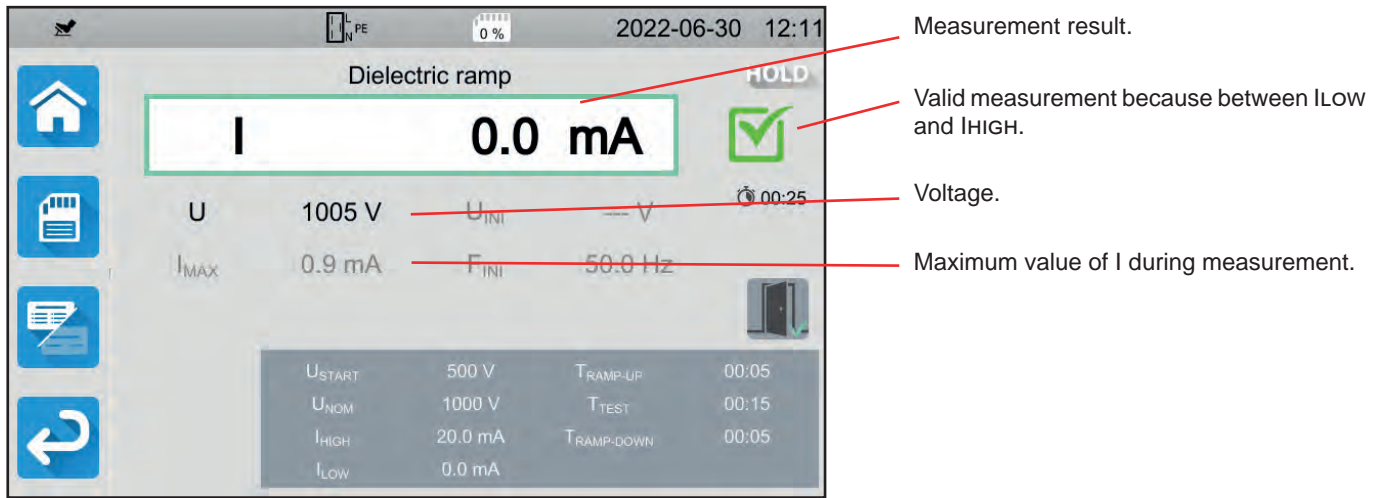



Figure 52

You can save the measurement result by pressing .

If you have connected a printer to the instrument you can also print a label by pressing the  key.

To make a new measurement, press the trigger. The button **Start / Stop** turns green again.

4.10.6. ERROR INDICATION

The most common error for a dielectric test is the presence of a voltage on the terminals. If a voltage above 25 V is detected and you press the **Start / Stop** button, the instrument displays an error message.

In this case, the measurement is not allowed. Remove the voltage, and repeat the measurement.

4.11. DIFFERENTIAL TEST (RCD)

The instrument can perform three types of test on RCDs:

- a non-tripping test.
- a tripping test in pulse mode,
- a tripping test in ramp mode.

The non-tripping test checks that the differential does not trip at a current of $0.5 I_{\Delta N}$. For this test to be valid, the leakage currents must be negligible compared to $0.5 I_{\Delta N}$ and, to do this, all the loads connected to the installation protected by the differential being tested must be disconnected.

The pulse mode test is used to determine the differential tripping time.

The ramp mode test is used to determine the exact value of the differential tripping current.

Press the **Unit tests**  icon then **RCD without tripping** , or on **Pulse RCD** , or on **Ramp RCD** .

4.11.1. DESCRIPTION OF THE MEASURING PRINCIPLE

For each of the three types of test, the instrument begins by checking that the differential test can be performed without compromising user safety, i.e. the fault voltage, U_L , does not exceed 25 V or 50 V depending on what the user has chosen.

The instrument generates a small current (12 mA) between L and PE in order to be able to measure $Z_{L-PE} = Z_s$.



It then calculates $U_f = Z_s \times I_{\Delta N}$ (or $Z_s \times I_{FACTOR} \times I_{\Delta N}$ depending on the configuration of the requested test) which will be the maximum voltage produced during the test. If this voltage is higher than U_L , the instrument does not perform the test.

Once this first part of the measurement has been carried out, the instrument moves on to the second part which depends on the type of test.

- For the non-tripping test, the instrument generates a current of $0.5 I_{\Delta N}$ for one or two seconds, depending on what the user has programmed. Normally, the differential should not trip.
- For the pulse mode test, the instrument generates a sinusoidal current at the mains frequency with an amplitude of $I_{FACTOR} \times I_{\Delta N}$ between terminals L and PE. It measures the time it takes for the differential to break the circuit. This time must be less than a time that depends on the type of differential (see § 8.2.5).
- For the ramp mode test, the instrument generates a sinusoidal current whose amplitude gradually rises, in stages, from 0.3 to $1.06 I_{\Delta N}$ between the L and PE terminals for type AC or A differentials and from 0.2 to $2.2 I_{\Delta N}$ for type B differentials. When the differential breaks the circuit, the instrument displays the exact value of the tripping current as well as the tripping time. This time is indicative and may be different from the tripping time in pulse mode, which is closer to the operating reality.

4.11.2. CONNECTION



If L and N are reversed, the instrument reports it  but measurement is possible. If L and PE are reversed , measurement is not possible. If N and PE are reversed, the instrument cannot detect it but the differential will trip as soon as the measurement begins.



Be careful not to connect the instrument's power supply to the circuit to be tested. Otherwise, when tripped it will turn off.

4.11.2.1. With the tripod cord - Schuko plug

- Connect the tripod plug to terminals L, N, PE of the instrument.
- Connect the Schuko plug to a socket protected by the circuit breaker to be tested.

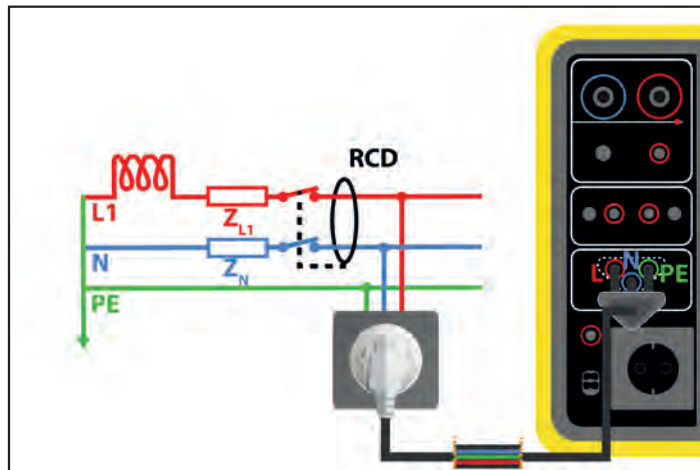

Figure 53

4.11.2.2. With the tripod cord - 3 safety cords

- Connect the tripod plug to terminals L, N, PE of the instrument.
- Connect the red lead to one of the phases of the installation protected by the differential to be tested.
- Connect the blue lead to the neutral of the installation protected by the differential to be tested.
- Plug the green cord into the installation PE.

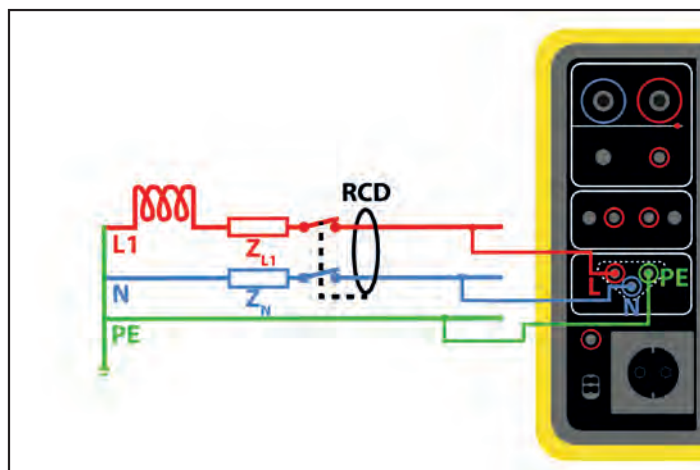

Figure 54

4.11.2.3. Upstream downstream assembly

This connection is used to test a differential located downstream of another whose nominal current is smaller.

- Connect the tripod plug to terminals **L**, **N**, **PE** of the instrument.
- Connect the red lead to one of the installation phases before the differential to be tested.
- Connect the blue lead and the green lead to the neutral of the installation after the differential to be tested.

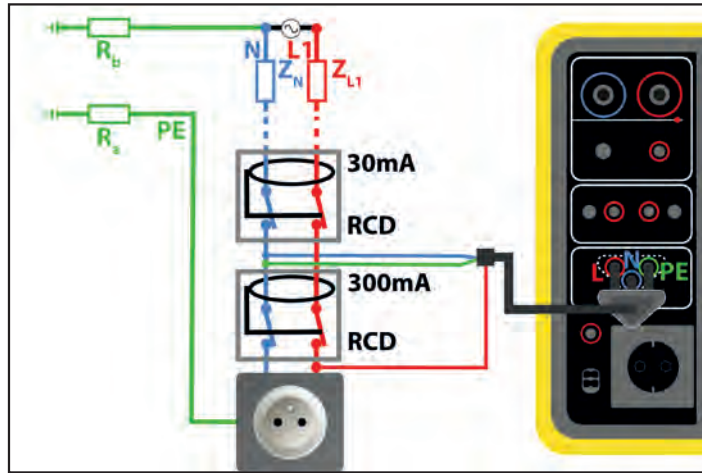

Figure 55

4.11.2.4. Upstream downstream assembly between phases

- Connect the tripod plug to terminals **L**, **N**, **PE** of the instrument.
- Connect the red lead to one of the installation phases before the differential to be tested.
- Connect the blue lead and the green lead to another phase of the installation after the differential to be tested.

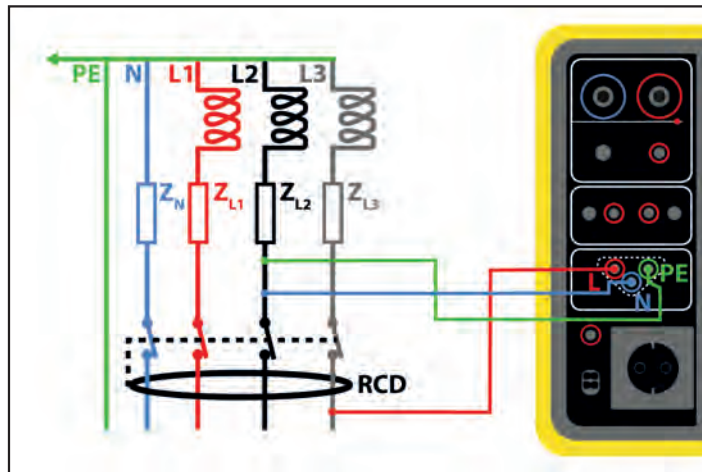

Figure 56

4.11.3. MEASUREMENT CONFIGURATION

4.11.3.1. RCD without tripping

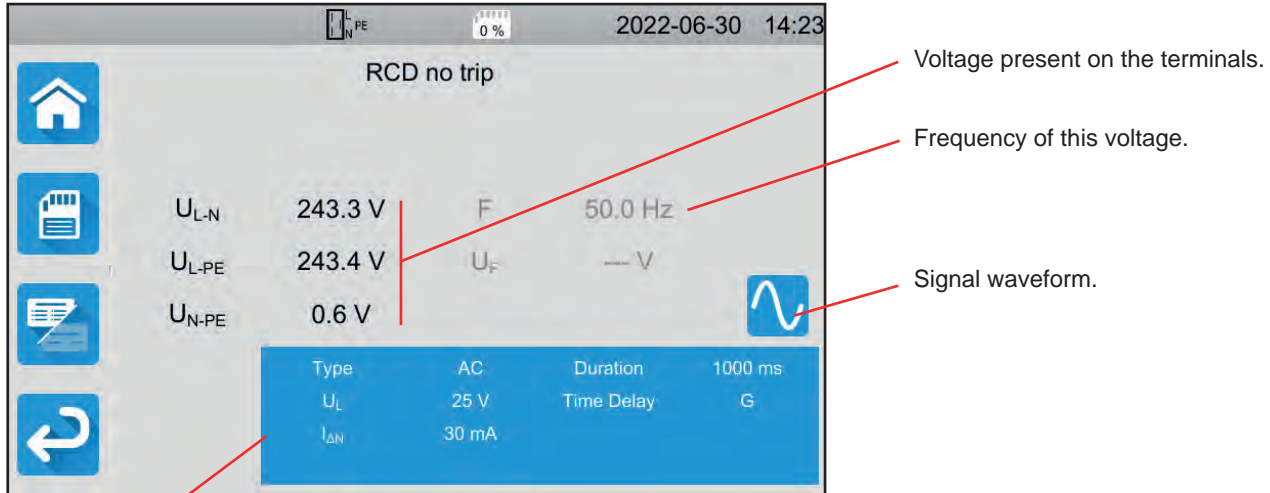

Figure 57

The parameters are in the blue rectangle. Press to modify them.

- U_L = fault voltage: 25, 50 or 65 V. This is the maximum voltage that the differential test can generate. The voltage of 50 V is the standard voltage (default). The voltage of 25 V is to be used for measurements in humid environments. The voltage of 65 V is the default voltage in some countries (Austria for example).
- Time Delay = G or S.
G: general type RCD, no delay between two tests.
S: selective type RCD.



When testing a type S RCD, it is necessary to wait 30 seconds between two tests, the time it depolarises.

- Type of differential = AC, A or B.
AC type RCD: trips on an AC fault.
Type A RCD: additionally trips on a fault on only positive or only negative alternations.
Type B RCD: additionally trips on a continuous fault.
- $I_{\Delta N}$: assigned operating current of the differential to be tested: 10mA, 30mA, 100mA, 300mA, 500mA, 1000mA or I_{VAR} (6 to 1000mA).
- $I_{\Delta N-VAR}$: the value of $I_{\Delta N}$ when you choose I_{VAR}. You can adjust it precisely between 6 mA and a maximum value given in the table below.
- I_{FORM} = signal waveform:
 - signal that begins with a positive alternation (RCD type AC, A and B).
 - signal that begins with a negative alternation (RCD type AC, A and B).
 - signal formed only of positive alternations (RCD of type A and B).
 - signal formed only of negative alternations (RCD of type A and B).
 - positive continuous signal (type B RCD).
 - negative continuous signal (type B RCD).
- Duration: Duration of signal application 1000 or 2000 ms.



To check the conformity of type A and B RCD, the tripping test must be carried out in both polarities.

Type of RCD	IFACTOR	IFORM	I _{ΔN} (mA)	IDN-VAR
AC	0.5 I _{ΔN}		10, 30, 100, 300, 500, 1,000	[6; 1,000]
	I _{ΔN}		10, 30, 100, 300, 500, 1,000	[6; 1,000]
	2 I _{ΔN}		10, 30, 100, 300, 500	[6; 500]
	5 I _{ΔN}		10, 30, 100, 300	[6; 300]
A	0.5 I _{ΔN}		10, 30, 100, 300, 500, 1,000	[6; 1,000]
	I _{ΔN}		10, 30, 100, 300, 500, 1,000	[6; 1,000]
	2 I _{ΔN}		10, 30, 100, 300, 500	[6; 500]
	5 I _{ΔN}		10, 30, 100, 300	[6; 300]
			10, 30, 100	[6; 100]
B	0.5 I _{ΔN}		10, 30, 100, 300, 500, 1,000	[6; 1,000]
	2 I _{ΔN}		10, 30, 100, 300, 500	[6; 500]
	4 I _{ΔN}		10, 30, 100, 300	[6; 300]
	5 I _{ΔN}		10, 30, 100, 300	[6; 300]
			10, 30, 100	[6; 100]
	10 I _{ΔN}		10, 30, 100	[6; 100]

Table 1

Shaded information is part of detailed mode. To remove them from the display, press and the display will switch to simple mode .

4.11.3.2. Pulse RCD

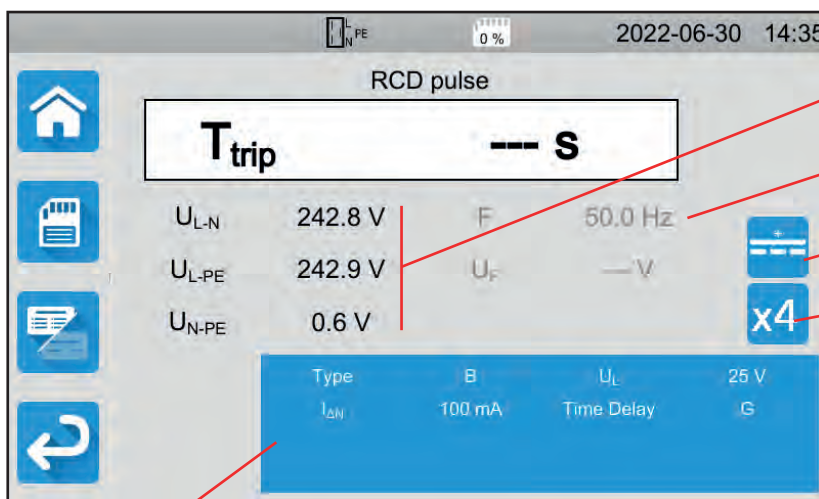

Figure 58

The parameters are in the blue rectangle. Press to modify them.

In addition to the previous settings:

IFACTOR = multiplicative factor of I_{ΔN}: 0.5, 1, 2, 4, 5 or 10. The possible values depend on the waveform of the signal, the value of I_{ΔN} and the type of differential (see table above).

4.11.3.3. Ramp RCD

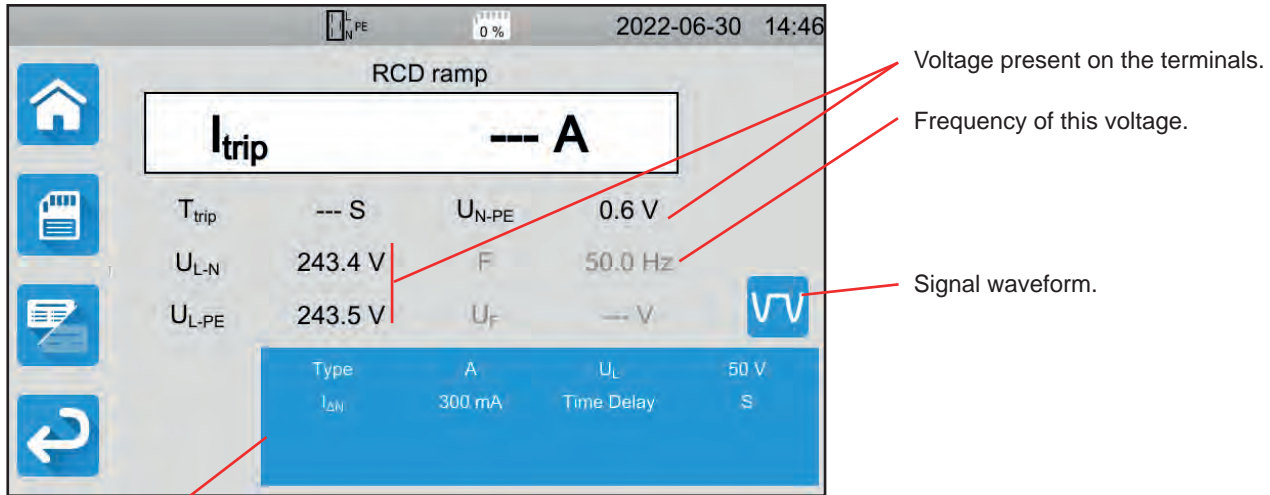

Figure 59

The parameters are in the blue rectangle. Press to modify them.

4.11.4. PERFORMING A DIFFERENTIAL TEST

The instrument checks the value of the voltages before starting a measurement. If the voltages are not correct, the **Start / Stop** button blinks red and you cannot start the test. Correct the problem so that the **Start / Stop** button turns green.

Press the **Start / Stop** button. It turns red for the duration of the test and then turns off.



In Ramp RCD test, you can see the current rise.

4.11.5. READING THE RESULT

4.11.5.1. Example for an RCD test without tripping, for a 300 mA circuit breaker, AC type, signal

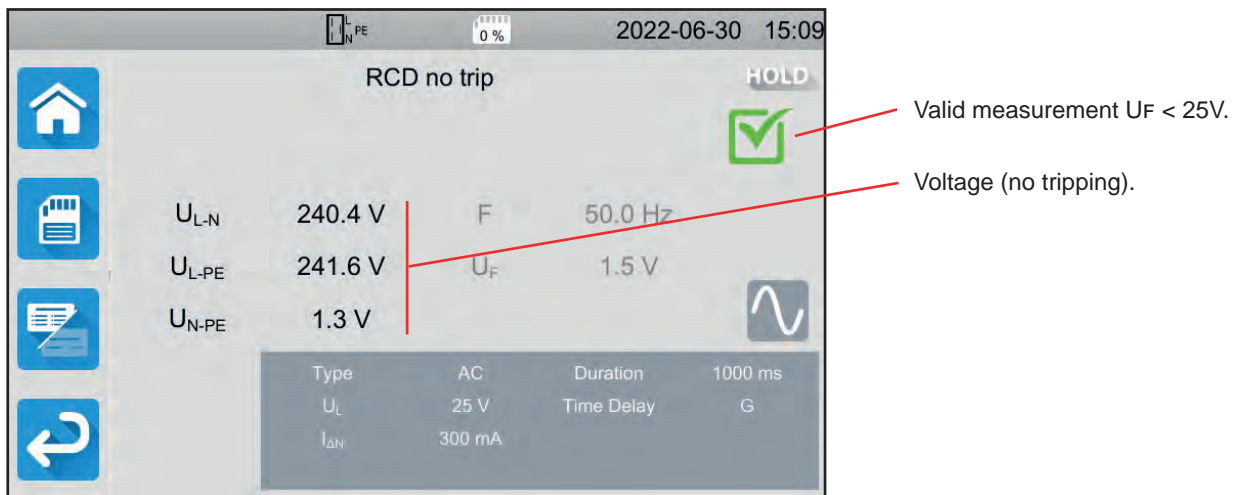

Figure 60

4.11.5.2. Example of a pulse RCD test, for a 30 mA circuit breaker, type B, signal

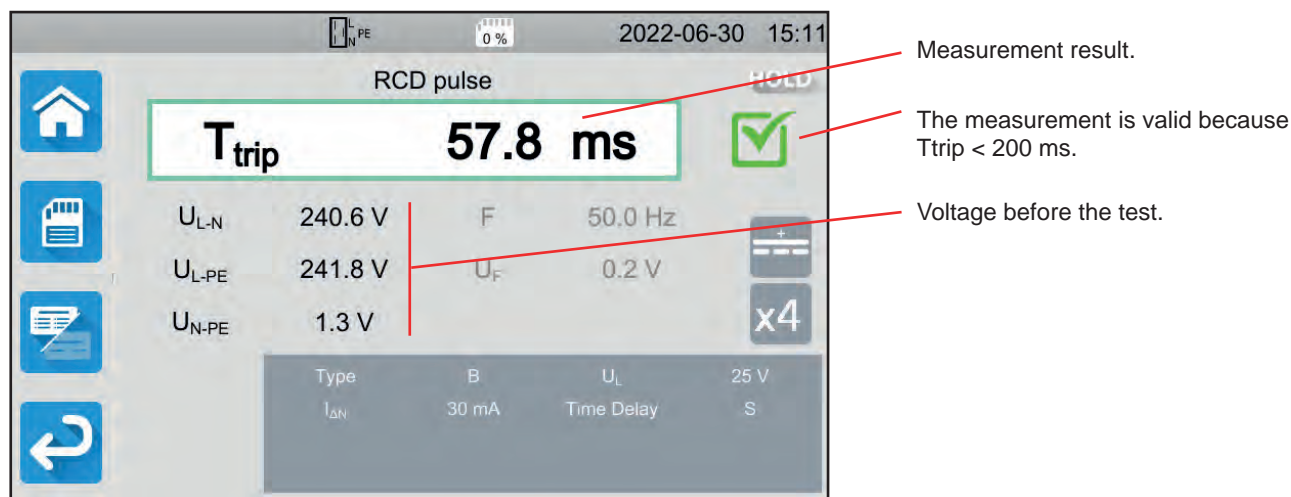

Figure 61

4.11.5.3. Example for a ramp RCD test, for a 100 mA circuit breaker, type A, signal

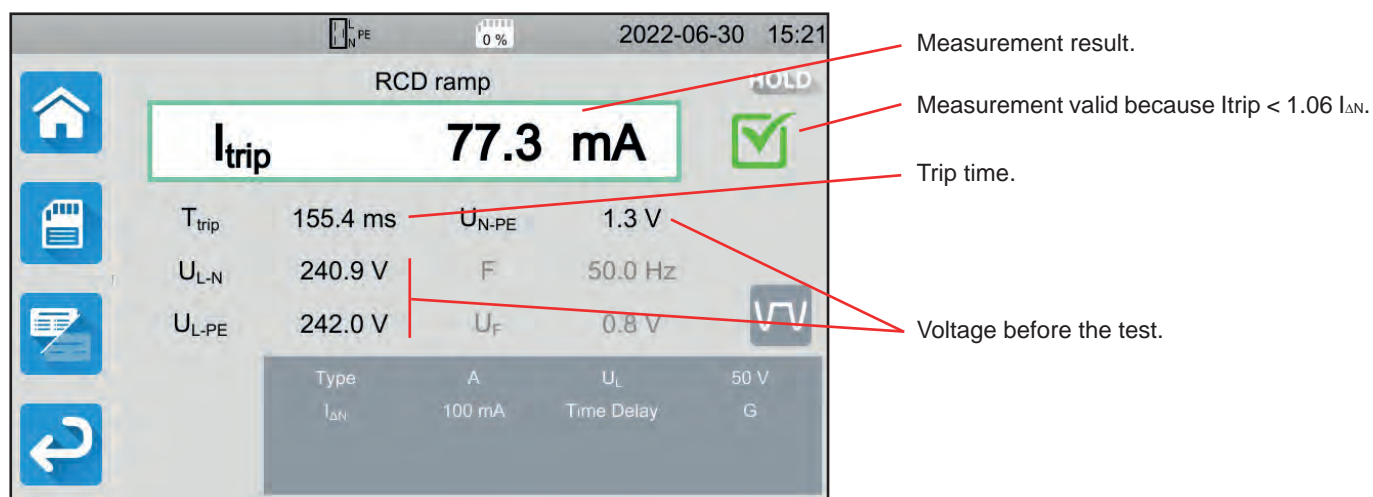



Figure 62

You can save the measurement result by pressing .

If you have connected a printer to the instrument you can also print a label by pressing the  key.

To make a new measurement, reset the differential that has tripped and press the **Start / Stop** button. It turns green.

4.11.6. ERROR INDICATION

The most common errors in a differential test are:

- Connection error: the **Start / Stop** button blinks red. Correct the connection. If necessary, use the tripod lead - 3 safety leads rather than the tripod lead - Schuko plug.
- Absence of voltage on the terminals: the **Start / Stop** button blinks red. Check the connection and also check that the circuit breaker is properly armed.
- The differential tripped when it shouldn't have. Leakage currents are probably too high. First disconnect all loads from the network on which you are performing the test. Then do a new test. If the problem persists, the differential is to be declared as faulty.
- The differential did not trip during the test. However, to guarantee user safety, a differential must trip within a defined time which depends on the type of differential.
Check the differential wiring.
Reverse N and PE and repeat the test.
Otherwise, the differential is to be declared defective and must be replaced.



4.12. LOOP IMPEDANCE MEASUREMENT (Zs)

In a TN or TT type installation, the loop impedance measurement is used to calculate the short-circuit current and to size the protections of the installation (fuses or differentials), in particular in terms of breaking capacity.

In a TT type installation, the loop impedance measurement makes it easy to determine the value of the earth resistance without having to plant a stake or cut off the power supply to the installation. The result obtained, Zs, is the loop impedance of the installation between the L and PE conductors. It is barely higher than the earth resistance.

Knowing this value and that of the contact voltage (UI), it is then possible to choose the rated differential operating current of the differential: $I_{\Delta N} < U_L / Z_s$.

This measurement cannot be made in an IT-type installation due to the high earthing impedance of the power supply transformer, or even its total isolation from earth.

Press the **Unit tests**  icon then **Loop impedance** .

4.12.1. DESCRIPTION OF THE MEASURING PRINCIPLE

For a low current measurement (No Trip):

The instrument absorbs a current between terminals L and N. Then it measures the voltage between these terminals and deduces $Z_{L-N} = Z_L$.

It then measures the voltage between N and PE and deduces Z_N .

Then it injects a current of 12 mA between terminals N and PE. This low current prevents tripping of differentials whose nominal current is greater than or equal to 30 mA. This third measurement makes it possible to determine Z_{N-PE} .

The instrument then calculates loop resistance $Z_s = Z_{L-PE} = Z_L + Z_{PE} = (Z_{L-N} - Z_N) + (Z_{N-PE} - Z_N)$, and the short-circuit current $I_k = U_{L-PE} / Z_s$.



The value of I_k is used to check the correct sizing of the installation protections (fuses or differentials).

For a high current measurement (Trip):

For better accuracy, it is possible to measure Zs with a high current (Trip mode), but this measurement may trip the installation's differential. The instrument absorbs a high current between the L and PE terminals and measures the voltage between these terminals. It deduces $Z_{L-PE} = Z_s$.

4.12.2. CONNECTION



If L and N are reversed , the instrument reports it but measurement is possible. If L and PE are reversed , measurement is not possible. If N and PE are reversed, the instrument cannot detect it but the differential will trip as soon as the measurement begins.

4.12.2.1. With the tripod cord - 3 safety cords

- Connect the tripod plug to terminals **L, N, PE** of the instrument.
- Connect the red lead to one of the installation phases.
- Connect the blue lead to the neutral of the installation.
- Plug the green cord into the installation PE.

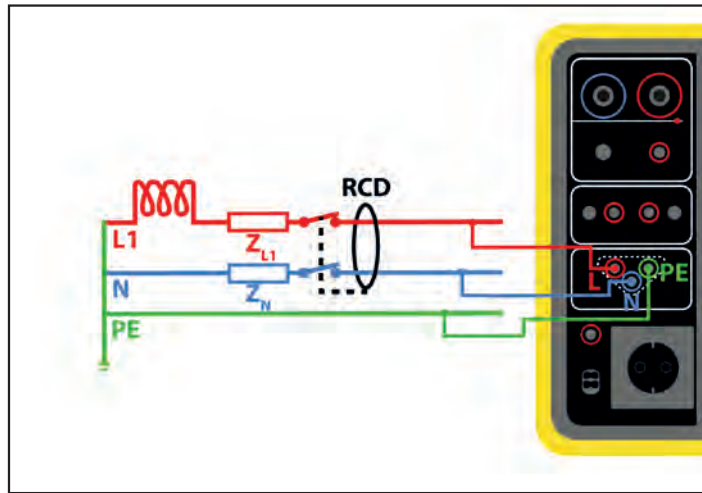

Figure 63

4.12.2.2. With tripod cord - Shuko plug

- Connect the tripod plug to terminals L, N, PE of the instrument.
- Connect the Schuko plug to a socket on the circuit to be tested.

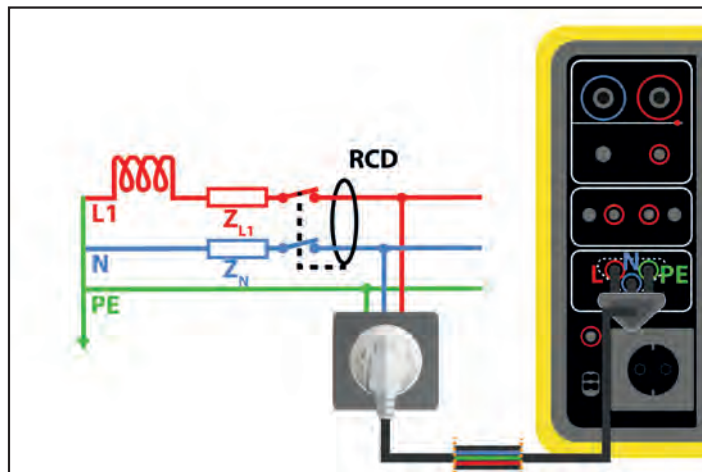

Figure 64

4.12.3. MEASUREMENT CONFIGURATION

The following screen is displayed:

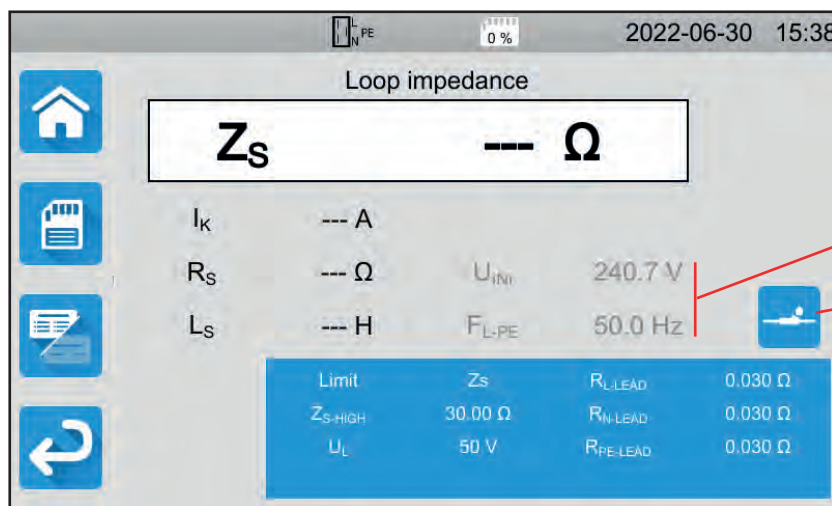



Figure 65

The parameters are in the blue rectangle. Press to modify them.

- Limit = Ik, Zs, Isc or OFF. To choose whether the measurement will be validated by Ik, Zs, Isc or none of the three.
- Ik-HIGH = maximum value of the short-circuit current. You can also choose MIN for the minimum value, MAX for the maximum value or OFF to give no upper limit. If the value of Ik is higher than Ik-HIGH, the measurement will be declared invalid.
- Zs-HIGH = maximum value of the loop impedance. You can also choose MIN for the minimum value, MAX for the maximum value or OFF to give no upper limit. If the measurement is higher than Zs-HIGH, it will be declared invalid.
- Isc-HIGH = maximum value of the current supported. This value is determined by the values of Fuse Delay, Fuse Type, Fuse In. If the value of Isc is higher than Isc-HIGH, the measurement will be declared invalid.
- Fuse Delay = Desired tripping time of the fuse: 35 ms, 0.1 s, 0.2 s, 0.4 s or 5 s.
- Fuse Type: LS-B, LS-C, LS-D, gG/gL. See § 11.3.
- Fuse In = Nominal current of the fuse: between 2 and 100 A.
- ITEST = No Trip or Trip. Test current value. In No Trip, the circuit breaker will not trip. In Trip, it may trip.
- UL = fault voltage: 25 or 50 V. This is the maximum permissible fault voltage during the measurement. The voltage of 50 V is the standard voltage (default). The voltage of 25 V is to be chosen for measurements in humid environments.
- Lead Compensation. Since the value of the loop impedance is very low, to have the most precise value possible, it is important to compensate for the value of the measurement leads. Default: this is the default value for the cords supplied with the instrument. User Defined: enter the resistance values of the 3 leads L, N and PE.

Shaded information is part of detailed mode. To remove them from the display, press  and the display will switch to simple mode .

4.12.4. PERFORMING A LOOP IMPEDANCE MEASUREMENT

The instrument checks the value of the voltages before starting a measurement. If the voltages are not correct, the **Start / Stop** button blinks and you cannot start the test. Correct the problem so that the **Start / Stop** button turns green.

Press the **Start / Stop** button. It turns red for the duration of the measurement then turns off.



4.12.5. READING THE RESULT

4.12.5.1. Example of a loop impedance measurement without tripping with a threshold on Zs

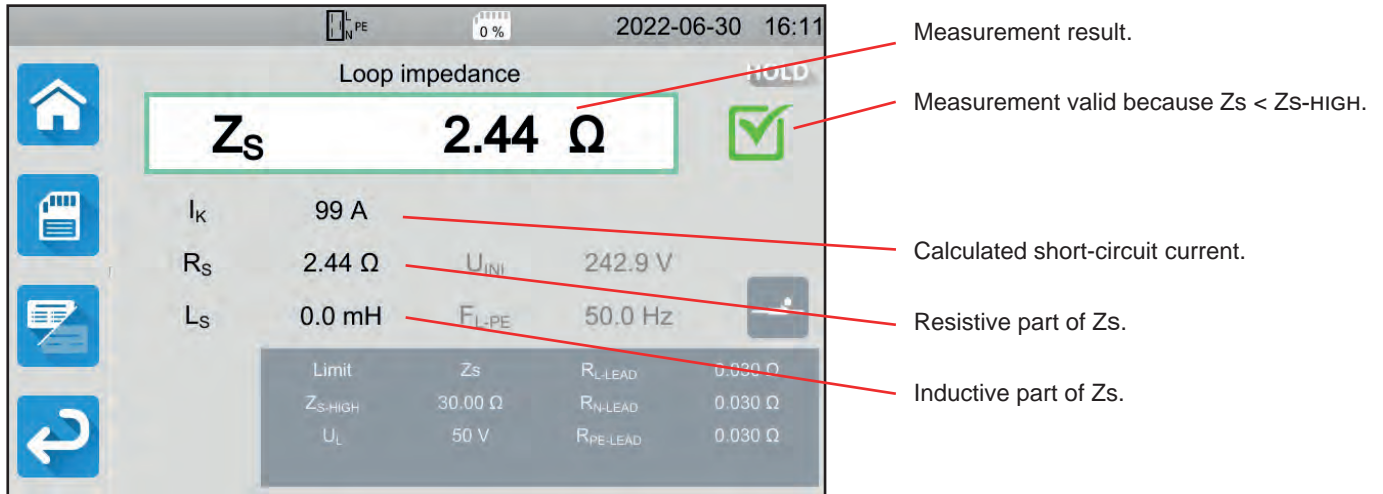

Figure 66

4.12.5.2. Example of a loop impedance measurement without tripping with a threshold on Ik

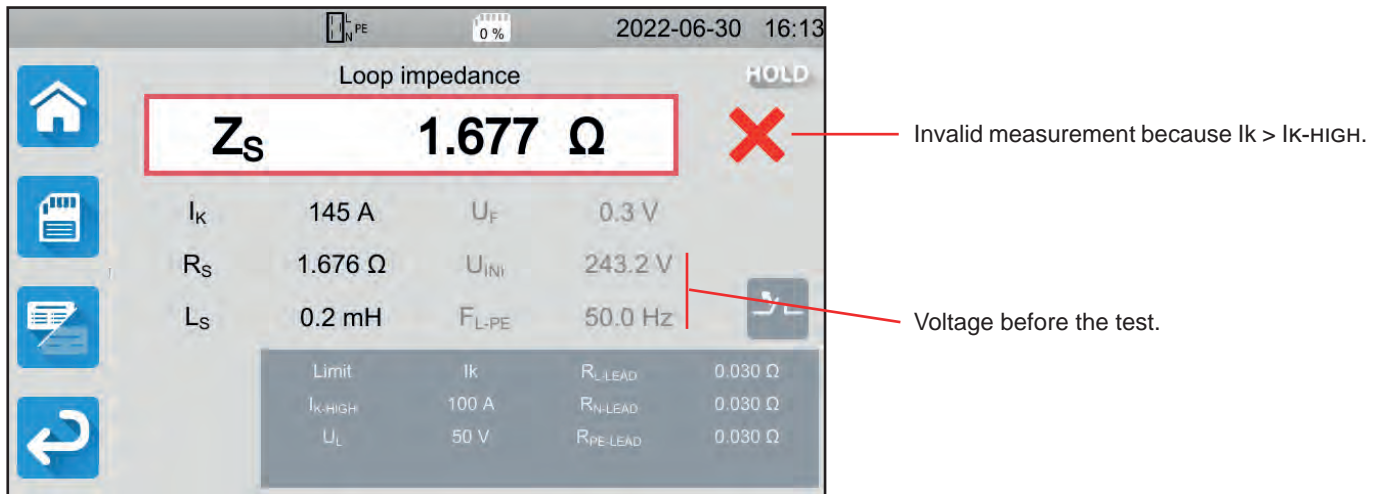

Figure 67

4.12.5.3. Example of a loop impedance measurement with tripping with a threshold on Zs

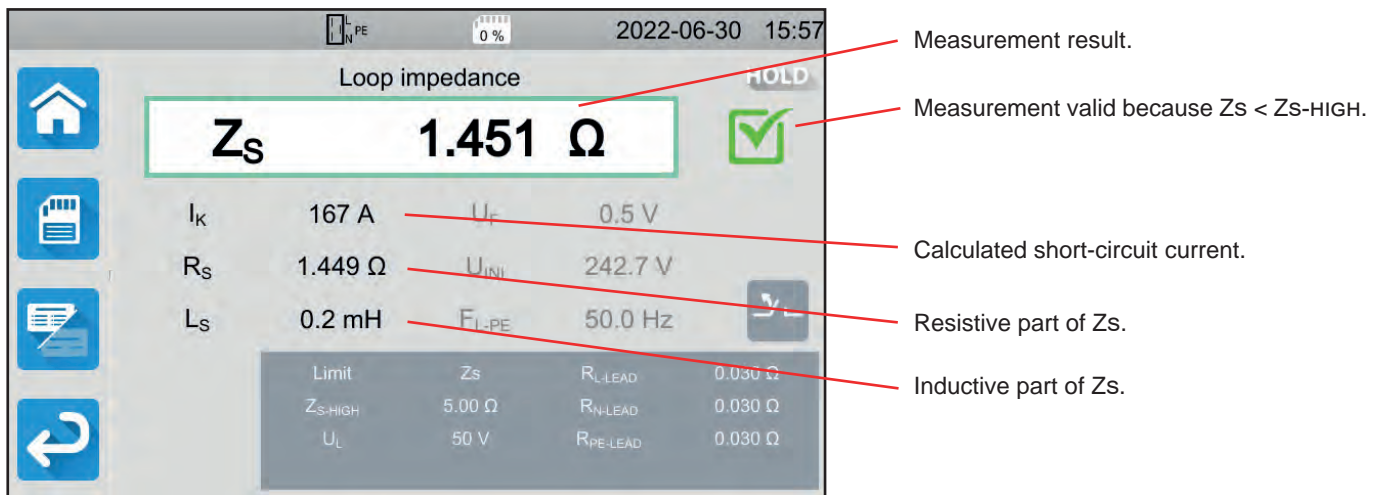



Figure 68

With a higher measurement current, measurement of Z_s is more accurate.

 Be careful not to connect the instrument's power supply to the circuit to be tested. Otherwise, when tripped it will turn off.

4.12.5.4. Example of a loop impedance measurement without tripping with a threshold on I_{sc}

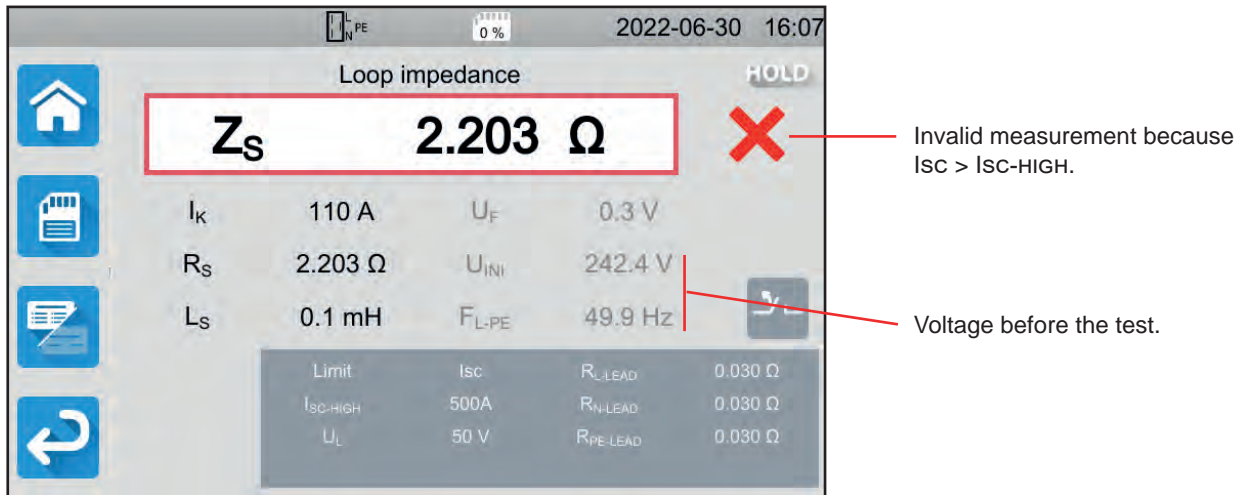



Figure 69

You can save the measurement result by pressing .

If you have connected a printer to the instrument you can also print a label by pressing the  key.

To make a new measurement, press the **Start / Stop** button. It turns green.

4.12.6. ERROR INDICATION

The most common errors in a loop measurement are:

- Connection error: the **Start / Stop** button blinks red. Correct the connection. If necessary, use the tripod lead - 3 safety leads rather than the tripod lead - Schuko plug.
- The voltage between N and PE is > 5 V: the **Start / Stop** button blinks red. Check the connection.
- Absence of voltage on the terminals: the **Start / Stop** button blinks red. Check the connection and also check that the circuit breaker is properly armed.
- The differential tripped during a No Trip test. Leakage currents are probably too high. Disconnect all loads from the network you are testing. Then do a new test.



4.13. LINE IMPEDANCE MEASUREMENT (Z_i)

Line impedance measurement Z_i (between L-N, or L1-L2, or L2- L3 or L1- L3) is used to calculate the short-circuit current and to size the protections of the installation (fuse or differential), whatever neutral system the installation has.

4.13.1. DESCRIPTION OF THE MEASURING PRINCIPLE

The instrument absorbs a high current between terminals L and N. Then it measures the voltage between these terminals and deduces $Z_{L-N} = Z_i$.

The instrument then calculates the short-circuit current $I_k = U_{L-N} / Z_i$ whose value is used to check the correct sizing of the protections of the installation.

Press the **Unit tests**  icon then **Line impedance** .

4.13.2. CONNECTION

4.13.2.1. With tripod cord - Shuko plug

- Connect the tripod plug to terminals L, N, PE of the instrument.
- Connect the Schuko plug to a socket on the circuit to be tested.

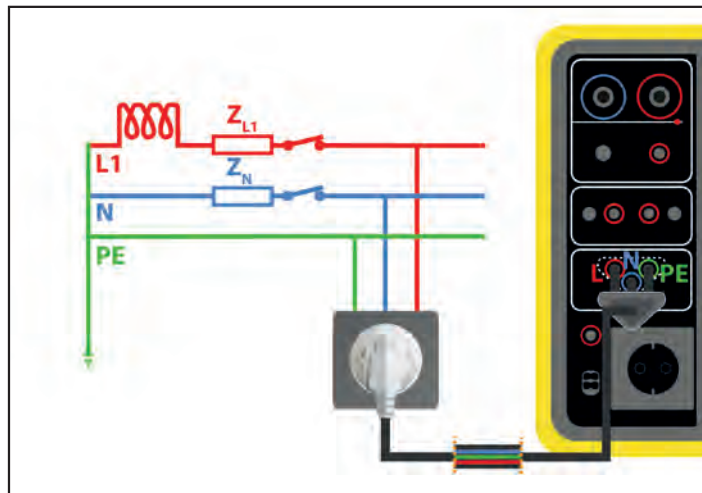

Figure 70

4.13.2.2. With the tripod cord - 3 safety cords on a single-phase network

- Connect the tripod plug to terminals L, N, PE of the instrument.

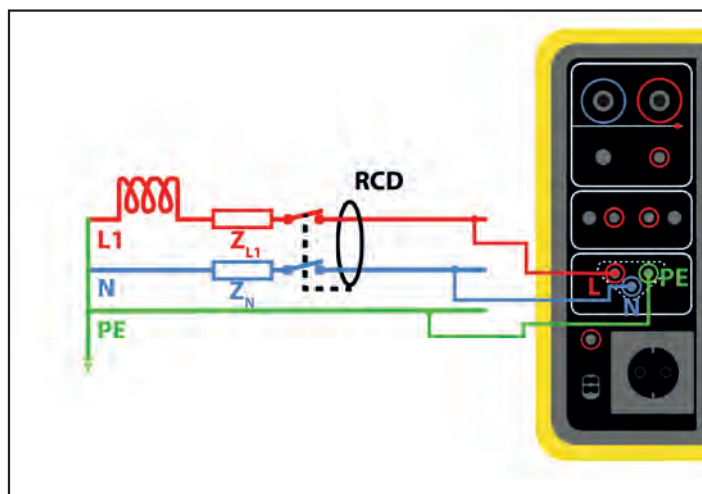





Figure 71

- Connect the red lead to the phase of the installation.
- Connect the blue lead to the neutral of the installation.
- Plug the green cord into the installation PE.

 If L and N are reversed, the instrument reports it  but measurement is possible. If L and PE are reversed , measurement is not possible. If N and PE are reversed, the instrument cannot detect it.

4.13.2.3. With the tripod cord - 3 safety cords on a three-phase network

- Connect the tripod plug to terminals L, N, PE of the instrument.
- Connect the red lead to one of the installation phases.
- Connect the blue lead to another phase of the installation.
- The green cord is not connected.

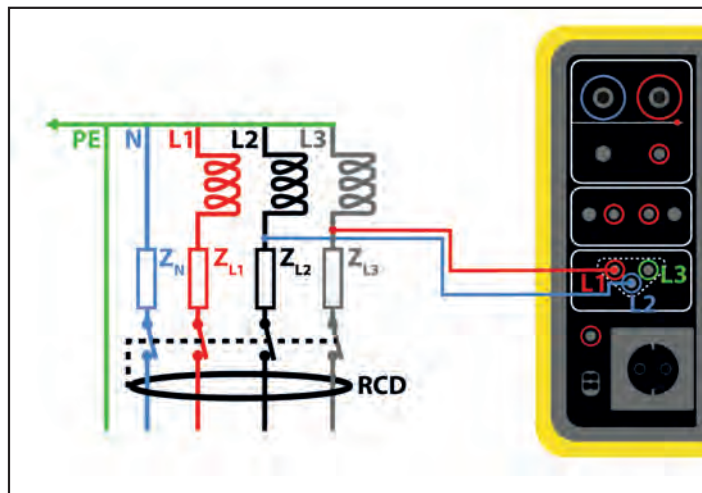

Figure 72

4.13.3. MEASUREMENT CONFIGURATION

The following screen is displayed:

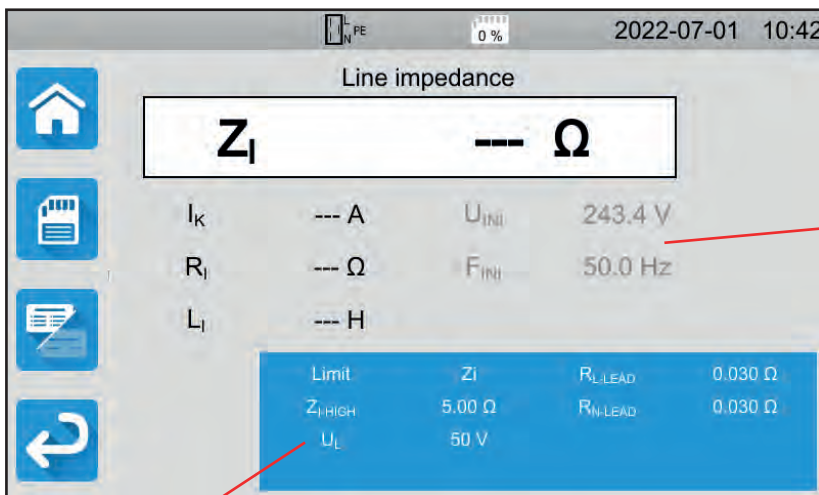
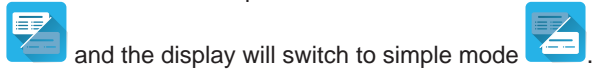

Figure 73

The parameters are in the blue rectangle. Press to modify them.

- Limit = I_k, Z_i, I_{sc} or OFF. To choose whether the measurement will be validated by I_k, Z_i, I_{sc} or none.
- I_k-HIGH = maximum value of the short-circuit current. You can also choose MIN for the minimum value, MAX for the maximum value or OFF to give no upper limit. If the value of I_k is higher than I_k-HIGH, the measurement will be declared invalid.
- Z_i-HIGH = maximum value of the line impedance. You can also choose MIN for the minimum value, MAX for the maximum value or OFF to give no upper limit. If the measurement is higher than Z_i-HIGH, it will be declared invalid.
- I_{sc}-HIGH = maximum value of the current supported. This value is determined by the values of Fuse Delay, Fuse Type, Fuse I_N. If the value of I_{sc} is higher than I_{sc}-HIGH, the measurement will be declared invalid.
- Fuse Delay = Desired tripping time of the fuse: 35 ms, 0.1 s, 0.2 s, 0.4 s or 5 s.
- Fuse Type: LS-B, LS-C, LS-D, gG/gL. See § 11.3.
- Fuse I_N = Nominal current of the fuse: between 2 and 100 A.
- U_L = fault voltage: 25 or 50 V. This is the maximum voltage that the line impedance measurement can generate. The voltage of 50 V is the standard voltage (default). The voltage of 25 V is to be chosen for measurements in humid environments.
- Lead Compensation. Since the value of the line impedance is very low, to have the most precise value possible, it is important to compensate for the value of the measurement leads. Default: this is the default value for the cords supplied with the instrument. User Defined: enter the resistance values of the 2 leads L and N.

Shaded information is part of detailed mode. To remove them from the display, press



4.13.4. PERFORMING A LINE IMPEDANCE MEASUREMENT

The instrument checks the value of the voltages before starting a measurement. If the voltages are not correct, the **Start / Stop** button blinks red and you cannot start the test. Correct the problem so that the **Start / Stop** button turns green.

Press the **Start / Stop** button. It turns red for the duration of the measurement then turns off.

4.13.5. READING THE RESULT



4.13.5.1. Example of a line impedance measurement with a threshold on Z_i

Measurement result.

Measurement valid because $Z_i < Z_i\text{-HIGH}$.

Calculated short-circuit current.

Resistive part of Z_i .

Inductive part of Z_i .

Figure 74

4.13.5.2. Example for a line impedance measurement with a threshold on I_k

Measurement valid because $I_k > I_{k-HIGH}$.

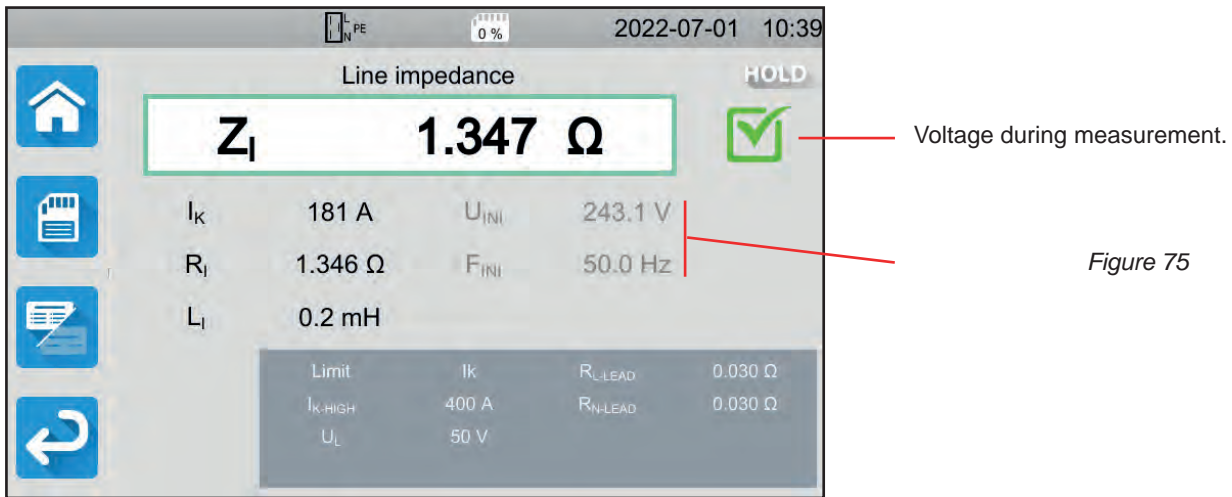

Figure 75

4.13.5.3. Example of a line impedance measurement with a threshold on I_{sc}

Invalid measurement because

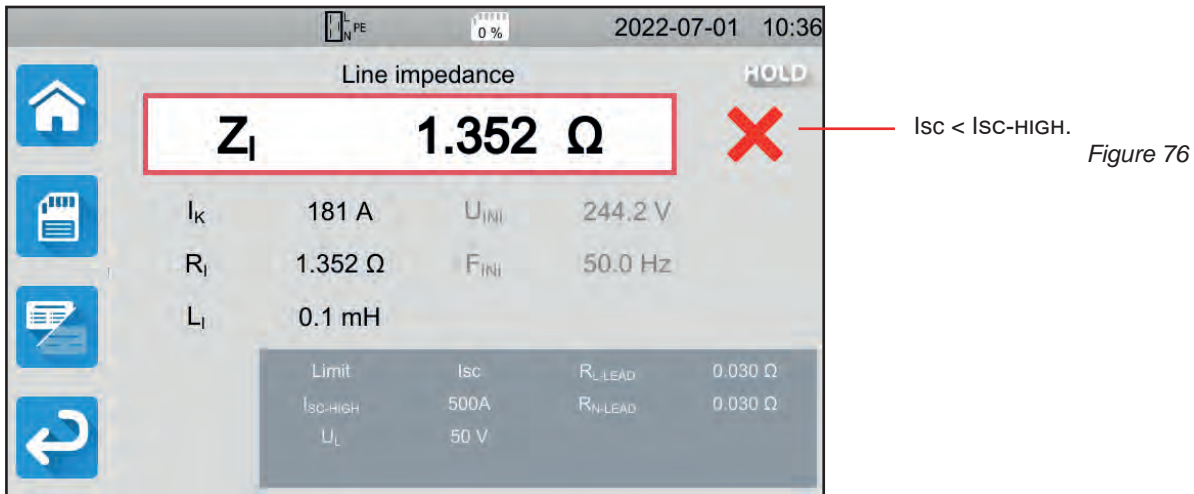



Figure 76

You can save the measurement result by pressing .

If you have connected a printer to the instrument you can also print a label by pressing the  key.

To make a new measurement, press the **Start / Stop** button. It turns green.

4.13.6. ERROR INDICATION

The most common errors in a line measurement are:

- Connection error: the **Start / Stop** button blinks red. Correct the connection. If necessary, use the tripod lead - 3 safety leads rather than the tripod lead - Schuko plug.
- Absence of voltage on the terminals: the **Start / Stop** button blinks red. Check the connection and also check that the circuit breaker is properly armed.

4.14. POWER MEASUREMENT

This function is used to measure:

- apparent power S,
- active power P,
- current I consumed by the machine,
- voltage UL-N,
- frequency f,
- power factors PF and $\cos \varphi$,
- total harmonic distortion in THDi current,
- total harmonic distortion in THDu voltage.

4.14.1. DESCRIPTION OF THE MEASURING PRINCIPLE

For a single-phase network, the instrument measures the voltage between L and PE, then it multiplies it by the current in the phase measured on the socket or by the clamp.

For a three-phase network, the instrument measures one of the three voltages between the phases, then it multiplies it by the current measured by the clamp. Then it multiplies everything by $\sqrt{3}$.

Press the **Unit tests**  icon then **Power** .

4.14.2. CONNECTION

4.14.2.1. Measurement via the test socket

This connection is used for a machine operating on single-phase, which has a Schuko-type mains socket and whose current consumption is less than or equal to 16 A.

- Select the **Test socket**  connection.
- Connect the mains plug of the machine to the **TEST SOCKET** of the instrument.

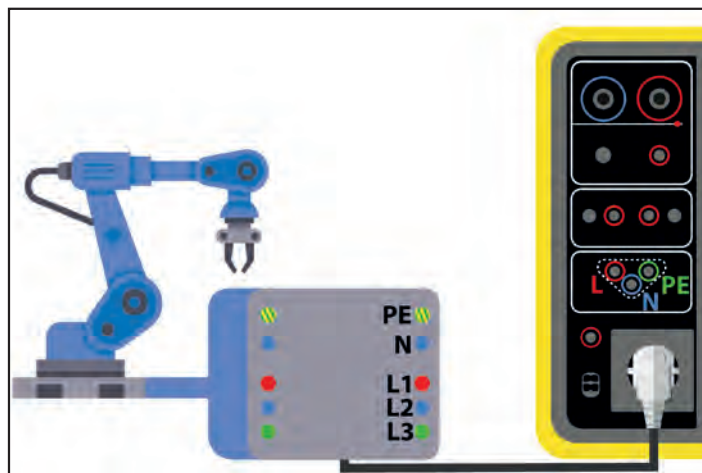



Figure 77

4.14.2.2. With the tripod cord - 3 safety cords and the (optional) G72 clamp on a single-phase network

This connection is used for a machine operating on single-phase and whose current consumption is higher than 16 A.

- Choose the **Clamp**  connection.
- Connect the tripod plug to terminals **L, N, PE** of the instrument.
- Connect the 3 safety leads to the mains power supply of the machine: the red lead to L, the blue lead to N and the green lead to PE.
- Connect the G72 clamp to the terminal  of the instrument then clamp on phase L. The arrow located on the case of the clamp must be oriented in the presumed direction of the current, therefore towards the machine.

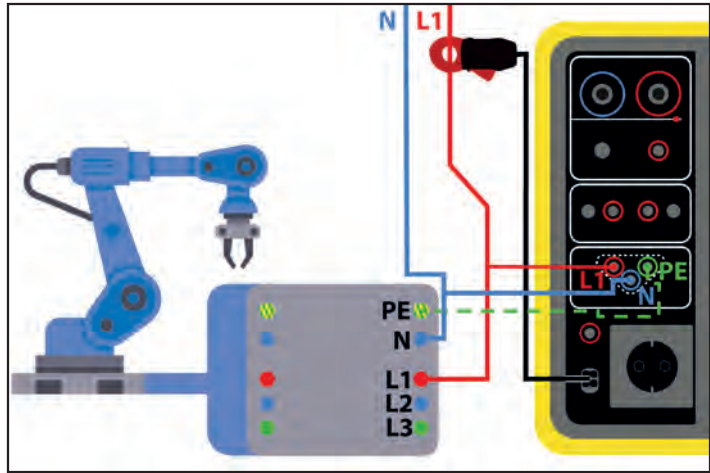



Figure 78

4.14.2.3. With the tripod cord - 3 safety cords and the (optional) G72 clamp on a three-phase network

- Choose the **Clamp**  connection.
- Connect the tripod plug to terminals **L, N, PE** of the instrument.
- Connect the 3 safety leads to the machine's mains power supply: the red lead to phase L1, the blue lead to phase L2 and the green lead to phase L3.
- Connect the G72 clamp to the terminal  of the instrument then clamp on phase L1. The arrow on the clamp housing should point in the presumed direction of current therefore towards the machine.

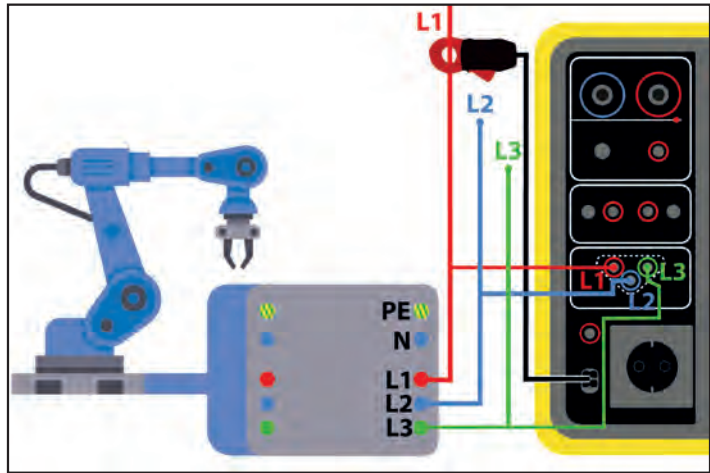

Figure 79

4.14.3. MEASUREMENT CONFIGURATION

For a measurement on the test socket, the following screen is displayed:

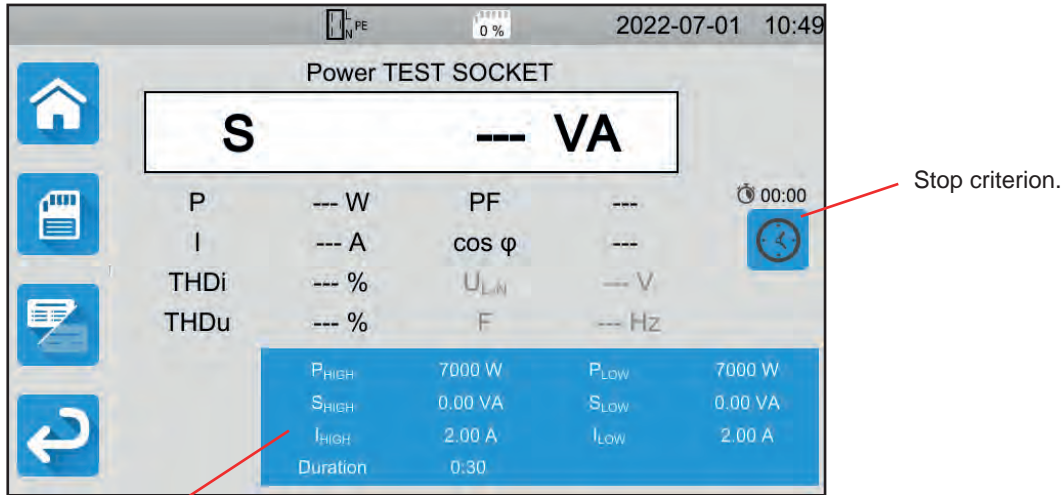





Figure 80

The parameters are in the blue rectangle. Press to modify them.

- P_{HIGH} = maximum value of active power. You can also choose MIN for the minimum value, MAX for the maximum value or OFF to give no upper limit. If the value of P is higher than P_{HIGH}, the measurement will be declared invalid.
- P_{LOW} = minimum value of active power. You can also choose MIN for the minimum value, MAX for the maximum value or OFF to give no lower limit. If the value of P is less than P_{LOW}, the measurement will be declared invalid.
- S_{HIGH} = maximum value of apparent power. You can also choose MIN for the minimum value, MAX for the maximum value or OFF to give no upper limit. If the measurement is higher than S_{HIGH}, it will be declared invalid.
- S_{LOW} = minimum value of apparent power. You can also choose MIN for the minimum value, MAX for the maximum value or OFF to give no lower limit. If the measurement is less than S_{LOW}, it will be declared invalid.
- I_{HIGH} = maximum value of the current consumed by the machine. You can also choose MIN for the minimum value, MAX for the maximum value or OFF to give no upper limit. If the value of I is higher than I_{HIGH}, the measurement will be declared invalid.
- I_{LOW} = minimum value of the current consumed by the machine. You can also choose MIN for the minimum value, MAX for the maximum value or OFF to give no lower limit. If the value of I is less than I_{LOW}, the measurement will be declared invalid.
- Stop Criterion: the measurement stops either automatically, or at the end of the defined duration, or manually.

You can also make this choice by pressing the  symbol.

-  the measurement will last the time required for its completion.
-  the measurement will last for the time you have programmed.
-  the measurement duration is manual. You start and stop it by pressing the **Start / Stop** button.
- Duration: duration of the measurement in seconds in the case of a measurement with a programmed duration. You can also choose MIN for the minimum time, MAX for the maximum time or OFF for automatic or manual measurement.

In the case of a measurement with clamp, the following screen is displayed:

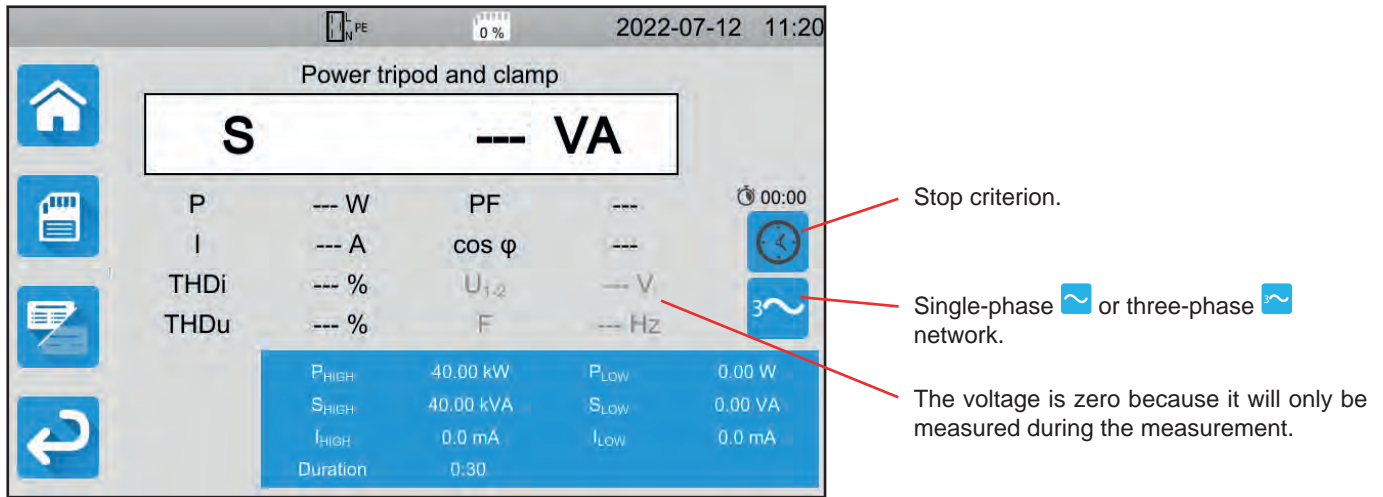

Figure 81

It is the same screen as for the measurement on the test socket but with the choice of the network in addition.

Shaded information is part of detailed mode. To remove them from the display, press and the display will switch to simple mode .

4.14.4. TAKING A POWER MEASUREMENT

The instrument checks the value of the voltages before starting a measurement. If the voltages are not correct, the **Start / Stop** button blinks red and you cannot start the test. Correct the problem so that the **Start / Stop** button turns green.

Press the **Start / Stop** button.

If it is a measurement on the test socket, the machine is powered by the instrument. The **Start / Stop** button turns red for the duration of the measurement then goes out.



If it is a measurement on the test socket, the machine is no longer powered by the instrument.

4.14.5. READING THE RESULT

4.14.5.1. Example of a power measurement on the test socket

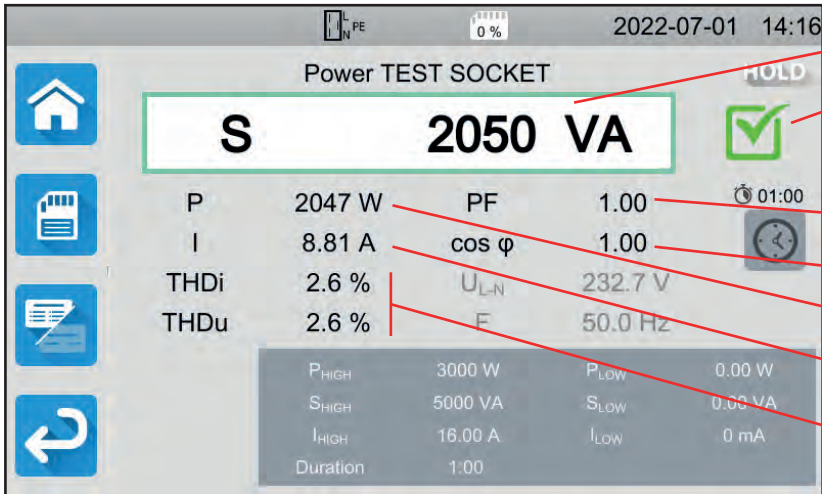

Measurement result, apparent power.

Valid measurement because:
 $P_{LOW} < P < P_{HIGH}$ and
 $S_{LOW} < S < S_{HIGH}$ and
 $I_{LOW} < I < I_{HIGH}$

Power factor PF.

cos φ.

Active power.

Current I consumed by the machine.

Total harmonic distortion in current and voltage.

Figure 82

4.14.5.2. Example of a single-phase power measurement with clamp

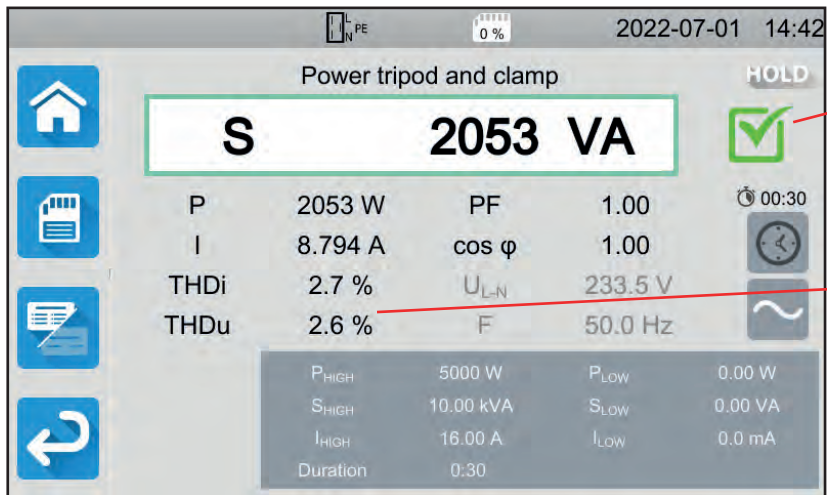

The measurement was stopped before the end of the programmed duration.

A high THD would indicate many harmonics.

Figure 83

You can save the measurement result by pressing .

If you have connected a printer to the instrument you can also print a label by pressing the  key.

To make a new measurement, press the **Start / Stop** button. It turns green.

4.14.6. ERROR INDICATION

The most common errors in a power measurement are:

- A mains voltage non-compliant in frequency, signal waveform, voltage level.
- In the case of a connection with clamp, a connection error.

4.15. POWER AND LEAKAGE CURRENT MEASUREMENT (CA 6163)

This measurement makes it possible to measure the power consumed by the machine, the leakage current in the PE and the contact current.

A leakage current is a sign of defective insulation. It may be due to ageing materials or a shock. As soon as its value reaches a few mA, it becomes dangerous for the user who risks electric shock in the event of a fault on the PE.

The contact current is measured on each accessible conductive part of the machine. It is also a sign of defective insulation. It may be due to ageing materials or a shock. As soon as its value reaches a few mA, it becomes dangerous for the user.

To measure the contact current, a measurement circuit is interposed between the **CONTINUITY TOUCH CURRENT** terminal and the PE. This measurement circuit is defined by the IEC 60990 standard and depends on the chosen threshold: unweighted, threshold of perception or non-release threshold.

This function is used to measure:

- the I_{diff} differential leakage current,
- apparent power S ,
- active power P ,
- the I_{touch} contact current,
- current consumed by the machine I ,
- power factor PF ,
- frequency f ,
- total harmonic distortion in $THDi$ current,
- total harmonic distortion in $THDu$ voltage.

Press the **Unit tests**  icon then **Power and leakage current** .

4.15.1. CONNECTION

- Connect the mains plug of the machine to the **TEST SOCKET** of the instrument.
- Connect a safety lead between the **CONTINUITY TOUCH CURRENT** terminal of the instrument and an accessible conductive part of the machine.
Take a measurement on each accessible conductive part: the frame, screws, hinges, latches, etc.

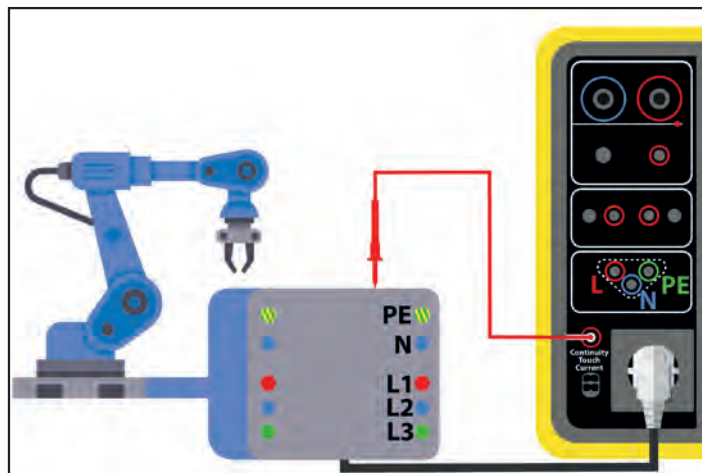

Figure 84

4.15.2. MEASUREMENT CONFIGURATION

The following screen is displayed:

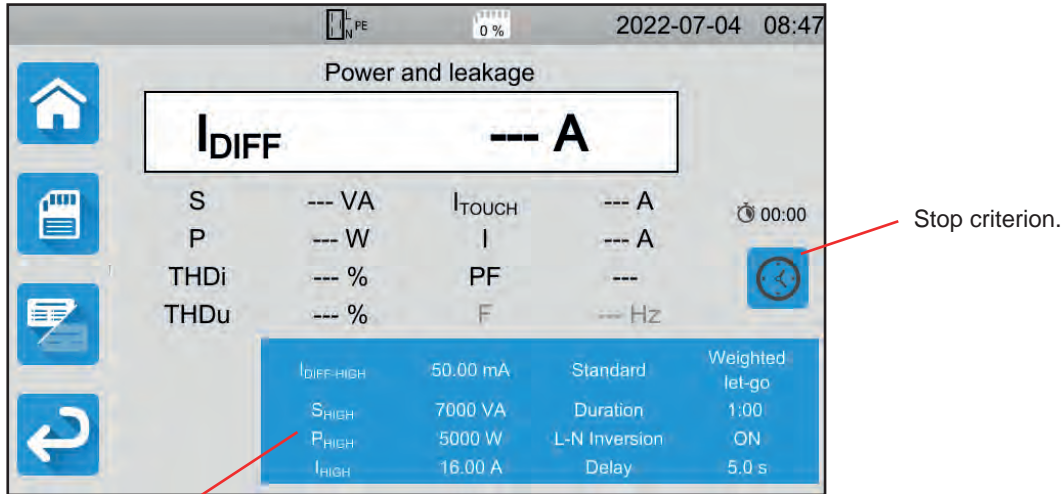





Figure 85



The parameters are in the blue rectangle. Press to modify them.

- I_{DIFF-HIGH} = maximum value of the leakage current. You can also choose MIN for the minimum value, MAX for the maximum value or OFF to give no upper limit. If the measurement of I_{DIFF} is higher than I_{DIFF-HIGH}, it will be declared invalid.
- I_{DIFF-LOW} = minimum value of the leakage current. You can also choose MIN for the minimum value, MAX for the maximum value or OFF to give no lower limit. If the measurement of I_{DIFF} is less than I_{DIFF-LOW}, it will be declared invalid.
- P_{HIGH} = maximum value of active power. You can also choose MIN for the minimum value, MAX for the maximum value or OFF to give no upper limit. If the value of P is higher than P_{HIGH}, the measurement will be declared invalid.
- P_{LOW} = minimum value of active power. You can also choose MIN for the minimum value, MAX for the maximum value or OFF to give no lower limit. If the value of P is less than P_{LOW}, the measurement will be declared invalid.
- S_{HIGH} = maximum value of apparent power. You can also choose MIN for the minimum value, MAX for the maximum value or OFF to give no upper limit. If the value of S is higher than S_{HIGH}, the measurement will be declared invalid.
- S_{LOW} = minimum value of apparent power. You can also choose MIN for the minimum value, MAX for the maximum value or OFF to give no lower limit. If the value of S is less than S_{LOW}, the measurement will be declared invalid.
- I_{HIGH} = maximum value of the current consumed by the machine. You can also choose MIN for the minimum value, MAX for the maximum value or OFF to give no upper limit. If the value of I is higher than I_{HIGH}, the measurement will be declared invalid.
- I_{LOW} = minimum value of the current consumed by the machine. You can also choose MIN for the minimum value, MAX for the maximum value or OFF to give no lower limit. If the value of I is less than I_{LOW}, the measurement will be declared invalid.
- Stop Criterion: the measurement stops either automatically, or at the end of the defined duration, or manually.

You can also make this choice by pressing the  symbol.

-  the measurement will last the time required for its completion.
-  the measurement will last for the time you have programmed.
-  the measurement duration is manual. You start and stop it by pressing the **Start / Stop** button.
- Duration: duration of the measurement in seconds in the case of a measurement with a programmed duration. You can also choose MIN for the minimum time, MAX for the maximum time or OFF for automatic or manual measurement.
- Standard: touch current threshold according to IEC 60990: unweighted threshold (Unweighted), threshold of perception (Weighted perception) or non-release threshold (Weighted let-go).
- L-N Inversion. This inversion is required by standard IEC 60990. At the end of the measurement, after the programmed delay, a new measurement is triggered with L and N reversed.

- Delay = time that elapses between the first measurement and the measurement with L and N reversed.

Shaded information is part of detailed mode. To remove them from the display, press  and the display will switch to simple mode .

4.15.3. TAKING A MEASUREMENT OF POWER AND LEAKAGE CURRENT

Press the **Start / Stop** button to start the measurement.

You can only press the **Start / Stop** button when it is green. It turns red for the duration of the measurement then turns off.



The machine is only powered for the duration of the measurement.

4.15.4. READING THE RESULT

4.15.4.1. Example of a measurement of power and leakage current with reversal of L and N and a threshold of non-release

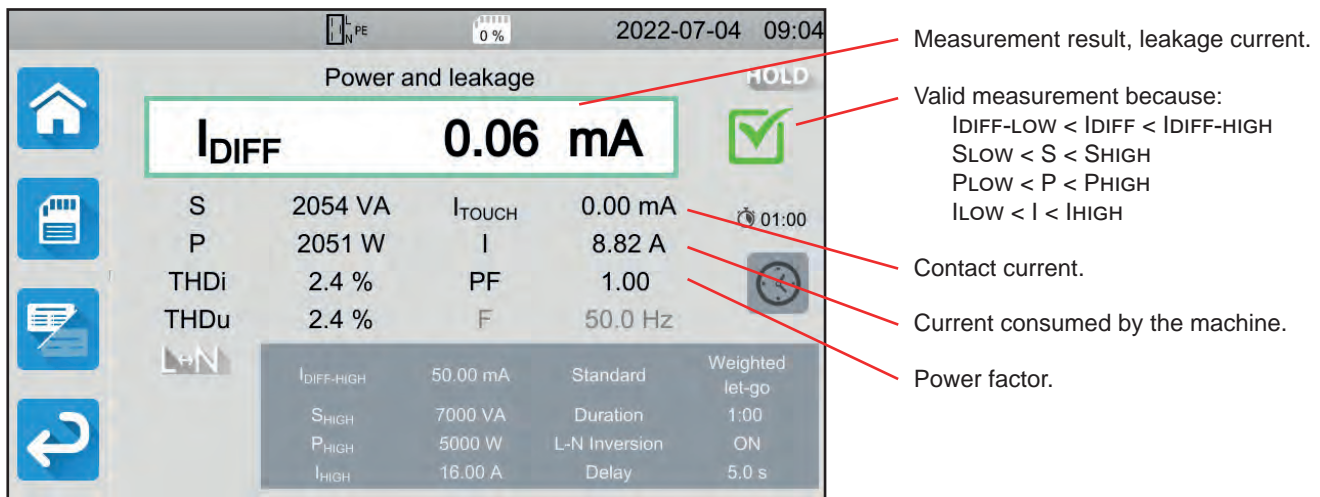

Figure 86

4.15.4.2. Example of a power and leakage current measurement and a threshold of perception

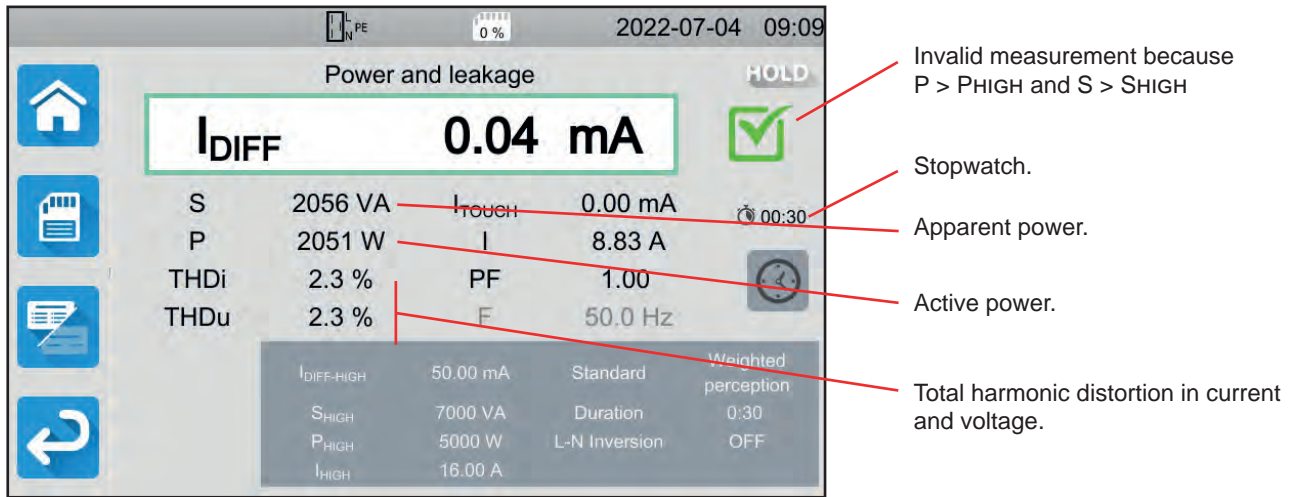

Figure 87

4.15.5. ERROR INDICATION

The most common error in power and leakage current measurement is:

- A mains voltage non-compliant in frequency, signal waveform, or voltage level.



4.16. LEAKAGE CURRENT MEASUREMENT

There are 3 leakage current measurements:

- direct leakage current,
- differential leakage current,
- leakage current by substitution (CA 6163).

4.16.1. DESCRIPTION OF THE MEASURING PRINCIPLE

- For direct leakage current measurement, the instrument measures the leakage current flowing in the PE.



Press the **Unit tests**  icon then **Direct leakage current** .

- For differential leakage current measurement, the instrument measures the differential current between phase and neutral.

Press the **Unit tests**  icon then **Differential leakage current** .

- For measurement of leakage current by substitution, the instrument supplies the machine with a voltage of 40 V and measures the differential current between L and N on the one hand and PE on the other hand. This measurement is made under low voltage and does not require electrical authorisation.

This method must not be used on equipment provided with switchgear that depends on line voltage (relays, contactors).

Press the **Unit tests**  icon then **Leakage current by substitution** .

4.16.2. CONNECTION

4.16.2.1. Measurement via the test socket

This connection is used for a machine operating on single-phase and whose current consumption is less than 16 A.

- Select the **Test socket**  connection.
- Connect the mains plug of the machine to the **TEST SOCKET** of the instrument.

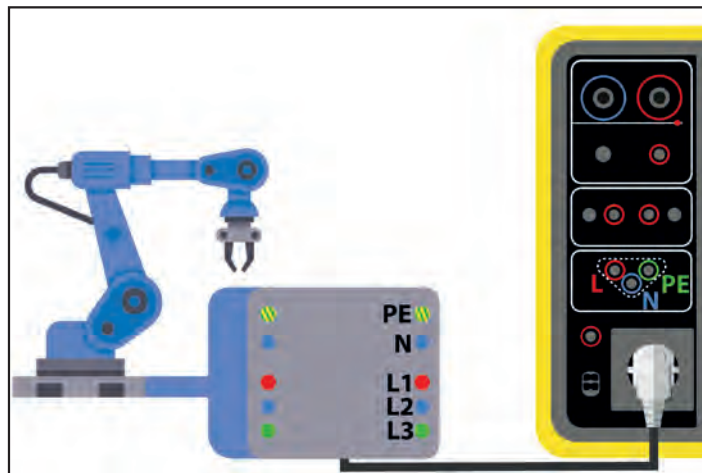

Figure 88

4.16.2.2. With the G72 clamp (optional) for direct leakage current measurement

This connection is used for a machine operating on single-phase whose current consumption is higher than 16 A or for a machine operating on three-phase.

- Choose the **Clamp** connection.
- Connect the machine to the mains with a special cord (not supplied) which allows the conductors to be separated.
- Connect the G72 clamp to the terminal of the instrument then clamp on the PE conductor. The arrow on the clamp housing should point in the presumed direction of current.

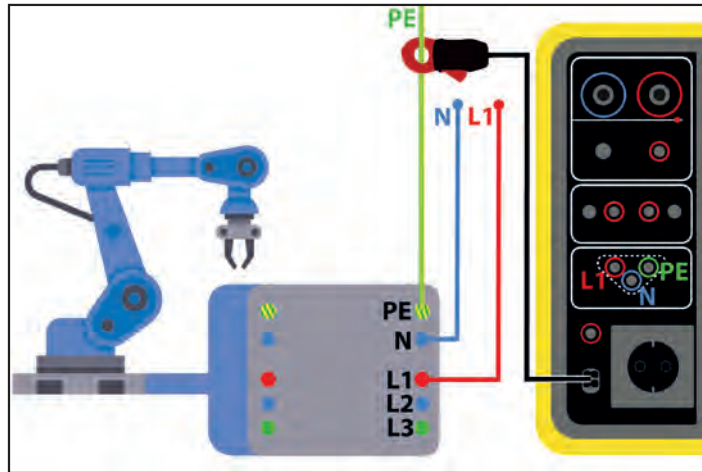

Figure 89

4.16.2.3. With the G72 clamp (optional) for differential leakage current measurement

This connection is used for a machine operating on single-phase whose current consumption is higher than 16 A or for a machine operating on three-phase.

- Choose the **Clamp** connection.
- Connect the machine to the mains with a special cord (not supplied) which allows the conductors to be separated.
- Connect the G72 clamp to the terminal of the instrument then clamp on a phase (L1, L2 or L3) and the neutral N. The arrow located on the casing of the clamp must be oriented in the presumed direction of the current.

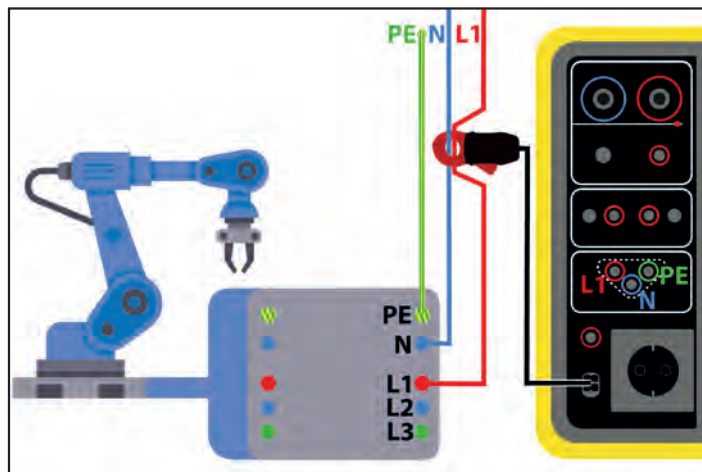

Figure 90

4.16.2.4. Measurement via the test socket for a substitution current measurement (CA 6163)

This connection is used for a machine operating on single-phase and whose current consumption is less than 16 A.

- Connect the mains plug of the machine to the **TEST SOCKET** of the instrument.

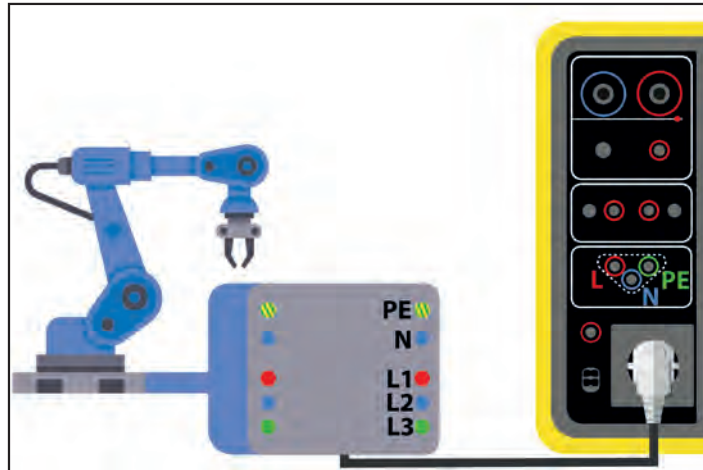

Figure 91

4.16.3. MEASUREMENT CONFIGURATION

For a measurement on the test socket, the following screen is displayed:

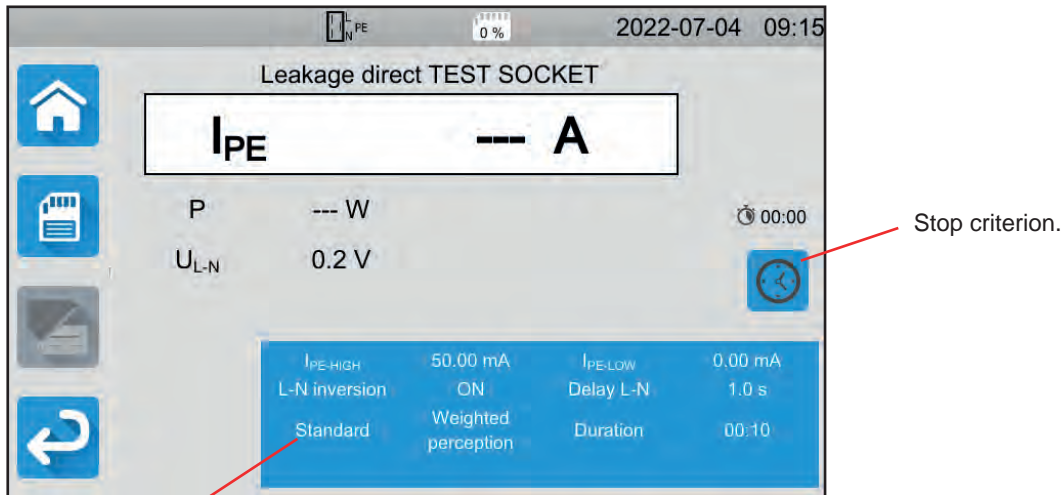





Figure 92

The parameters are in the blue rectangle. Press to modify them.

- IPE-HIGH = maximum value of direct leakage current. You can also choose MIN for the minimum value, MAX for the maximum value or OFF to give no upper limit. If the measurement of IPE is higher than IPE-HIGH, it will be declared invalid.
- IPE-LOW = minimum value of the direct leakage current. You can also choose MIN for the minimum value, MAX for the maximum value or OFF to give no lower limit. If the measurement of IPE is less than IPE-LOW, it will be declared invalid.
- IDIFF-HIGH = maximum value of the differential leakage current. You can also choose MIN for the minimum value, MAX for the maximum value or OFF to give no upper limit. If the measurement of IDIFF is higher than IDIFF-HIGH, it will be declared invalid.
- IDIFF-LOW = minimum value of the differential leakage current. You can also choose MIN for the minimum value, MAX for the maximum value or OFF to give no lower limit. If the measurement of IDIFF is less than IDIFF-LOW, it will be declared invalid.
- ISUBS-HIGH = maximum value of the substitution leakage current. You can also choose MIN for the minimum value, MAX for the maximum value or OFF to give no upper limit. If the measurement of ISUBS is higher than ISUBS-HIGH, it will be declared invalid.

- $I_{SUBS-LOW}$ = minimum value of substitution leakage current. You can also choose MIN for the minimum value, MAX for the maximum value or OFF to give no lower limit. If the measure of I_{SUBS} is less than $I_{SUBS-LOW}$, it will be declared invalid.
- Stop Criterion: the measurement stops either automatically, or at the end of the defined duration, or manually.

You can also make this choice by pressing the  symbol:

-  the measurement will last the time required for its completion.
-  the measurement will last for the time you have programmed.
-  the measurement duration is manual. You start and stop it by pressing the **Start / Stop** button.
- Duration: duration of the measurement in seconds in the case of a measurement with a programmed duration. You can also choose MIN for the minimum time, MAX for the maximum time or OFF for automatic or manual measurement.
- Standard: touch current threshold according to IEC 60990: unweighted threshold (Unweighted), threshold of perception (Weighted perception) or non-release threshold (Weighted let-go).
- L-N Inversion. This inversion is required by standard IEC 60990. At the end of the measurement, after the programmed delay, a new measurement is triggered with L and N reversed.
- Delay = time that elapses between the first measurement and the measurement with L and N reversed.

In the case of a measurement with clamp, the following screen is displayed:

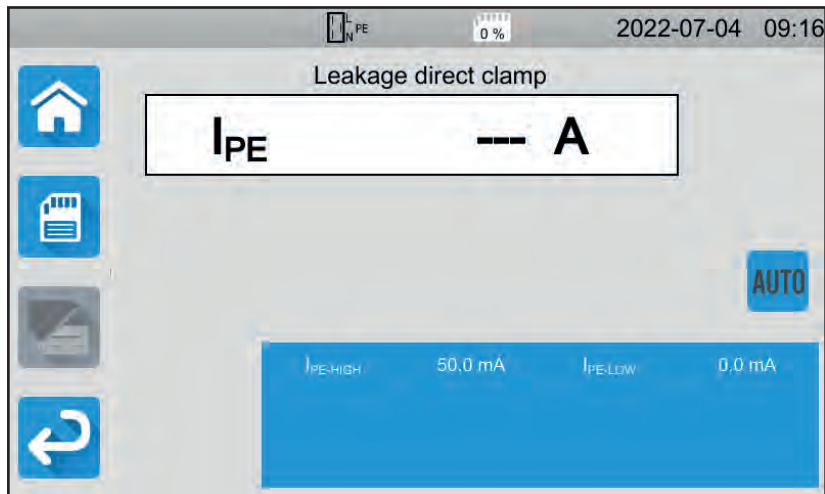

Figure 93

The Standard and Inversion L and N parameters are no longer accessible.

4.16.4. TAKING A LEAKAGE CURRENT MEASUREMENT

Press the **Start / Stop** button to start the measurement.

You can only press the **Start / Stop** button when it is green. It turns red for the duration of the measurement then turns off.



When the machine is plugged into the **TEST SOCKET** of the instrument, it is powered for the duration of the measurement.

4.16.5. READING THE RESULT

4.16.5.1. Example for a direct leakage current measurement on the test socket with an inversion of L and N and a non-release threshold

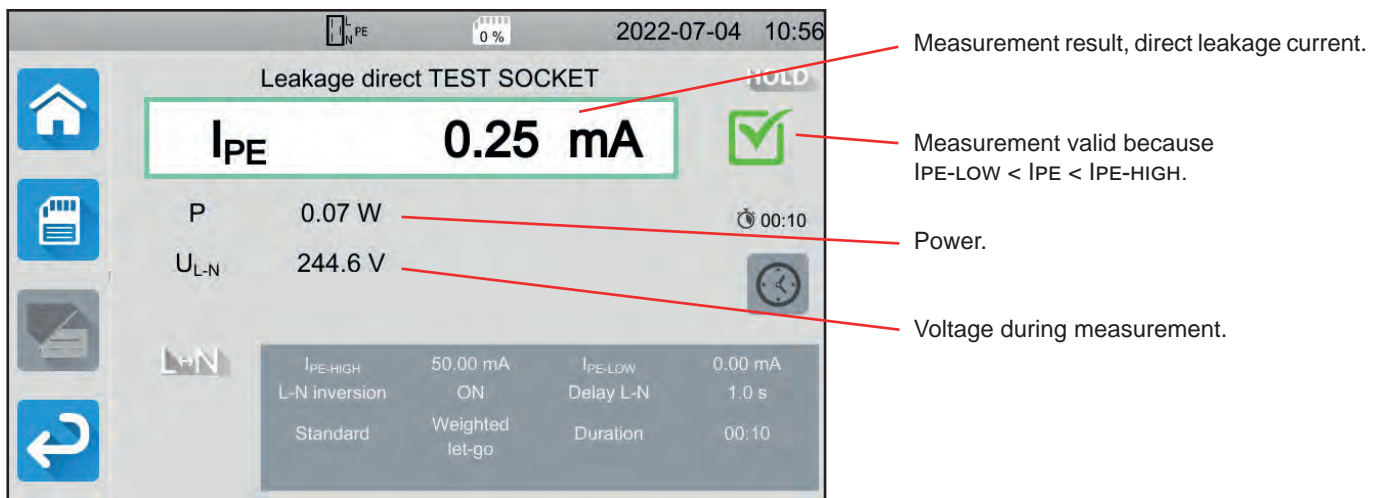

Figure 94

4.16.5.2. Example of a differential leakage current measurement on the test socket without inversion of L and N

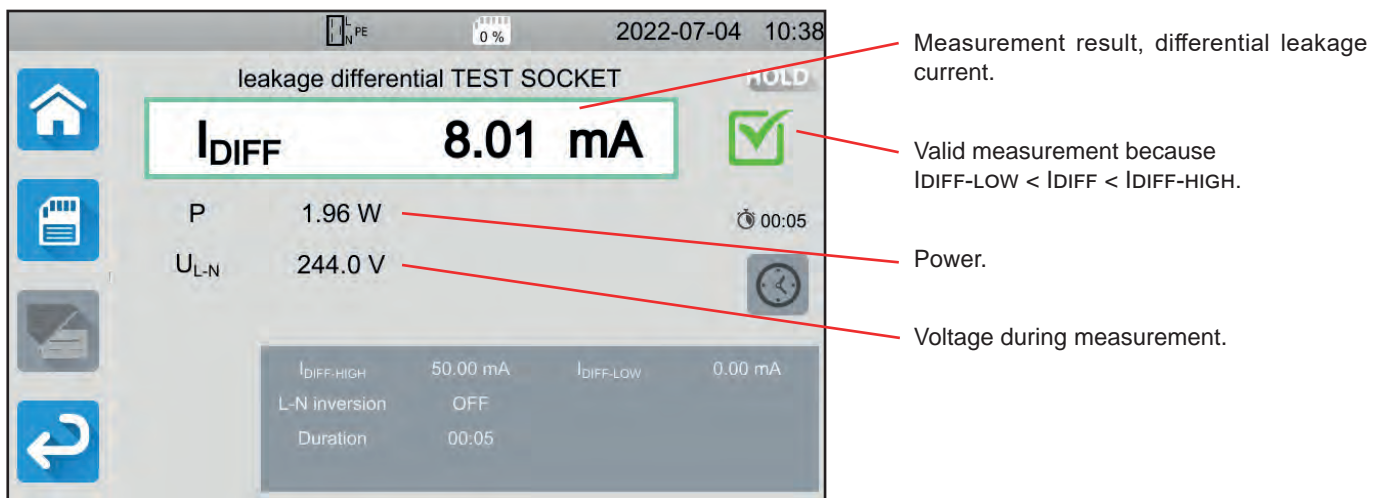
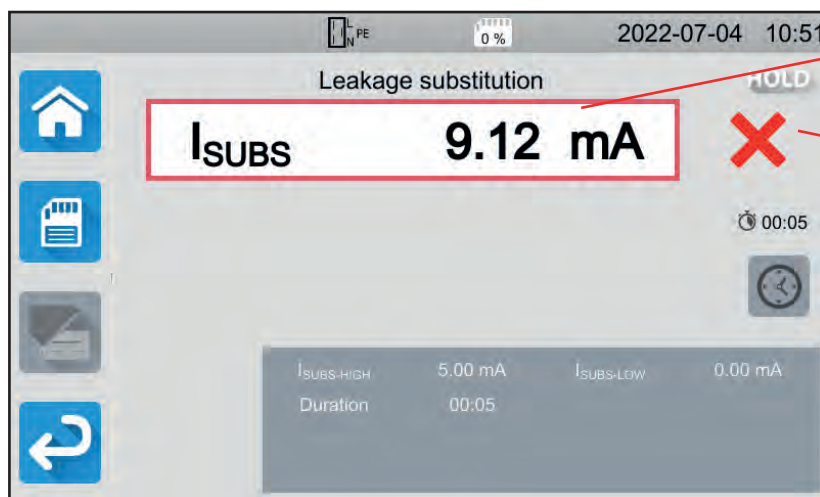

Figure 95

4.16.5.3. Example of a leakage current measurement by substitution (CA 6163)



Measurement result, leakage current by substitution.

Measurement invalid because I_{SUBS} > I_{SUBS-HIGH}.

Figure 96

4.16.6. ERROR INDICATION

The most common error in power and leakage current measurement is:

- A mains voltage non-compliant in frequency, signal waveform, voltage level.

4.17. CONTACT CURRENT MEASUREMENT (CA 6163)

This measurement makes it possible to measure the contact current, i.e. the current that a user would experience when touching an accessible metal part of the machine. A contact current is a sign of defective insulation. It may be due to ageing materials or a shock. As soon as its value reaches a few mA, it becomes dangerous for the user who risks electric shock.

This measurement also makes it possible to simulate a break in the PE and to measure the resulting increase in contact current.

Press the **Unit tests**  icon then **Contact current** .

4.17.1. CONNECTION

4.17.1.1. Measurement via the test socket

This connection is used for a machine operating on single-phase and whose current consumption is less than 16 A.

- Select the **Test socket**  connection.
- Connect the mains plug of the machine to the **TEST SOCKET** of the instrument.
- Connect a safety lead between the **CONTINUITY TOUCH CURRENT** terminal of the instrument and an accessible conductive part of the machine.

Take a measurement on each accessible conductive part: the frame, screws, hinges, latches, etc.

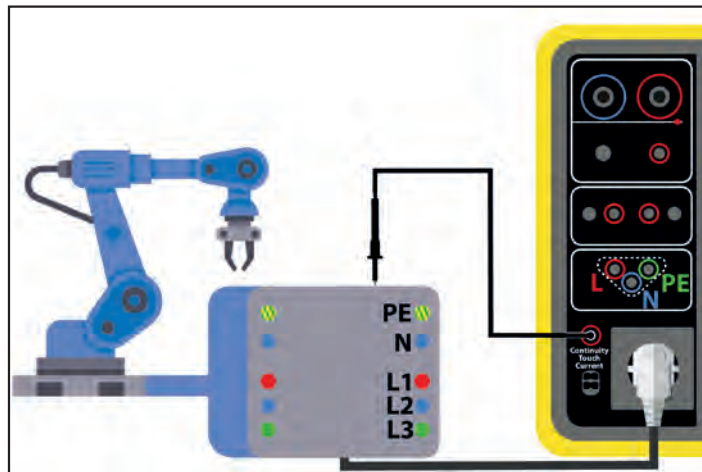



Figure 97

4.17.1.2. With the tripod cord - 3 safety cords single-phase

This connection is used for a machine operating on single-phase and whose current consumption is higher than 16 A.

- Choose the tripod connection .
 - Connect the tripod plug to terminals **L, N, PE** of the instrument.
 - Connect the red lead to the phase of the machine power supply.
 - Connect the blue lead to the neutral of the machine power supply.
 - Connect the green lead to the protective conductor of the machine power supply.
 - Connect a safety lead between the **CONTINUITY TOUCH CURRENT** terminal of the instrument and an accessible conductive part of the machine.
- Take a measurement on each accessible conductive part: the frame, screws, hinges, latches, etc.

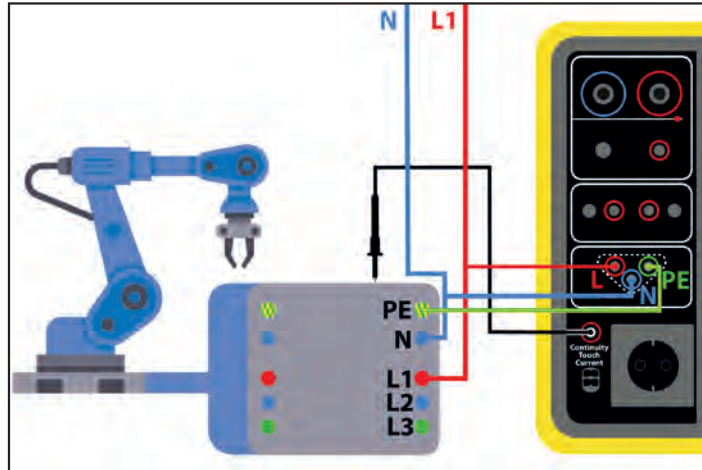



Figure 98

4.17.1.3. With the tripod cord - 3 three-phase safety leads

This connection is used for a machine operating on three-phase.

- Choose the tripod connection .
 - Connect the tripod plug to terminals **L, N, PE** of the instrument.
 - Connect the red lead to phase L1 of the machine power supply.
 - Connect the blue lead to phase L2 of the machine power supply.
 - Connect the green lead to phase L3 of the machine power supply.
 - Connect a safety lead between the **CONTINUITY TOUCH CURRENT** terminal of the instrument and an accessible conductive part of the machine.
- Take a measurement on each accessible conductive part: the frame, screws, hinges, latches, etc.

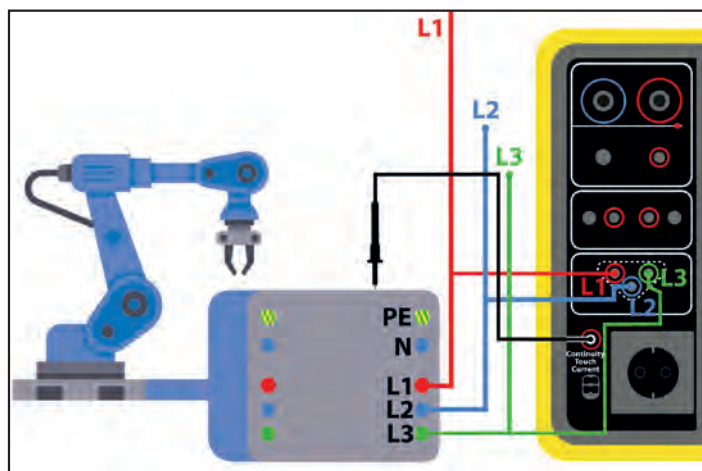

Figure 99

4.17.2. MEASUREMENT CONFIGURATION

For a measurement on the test socket, the following screen is displayed:

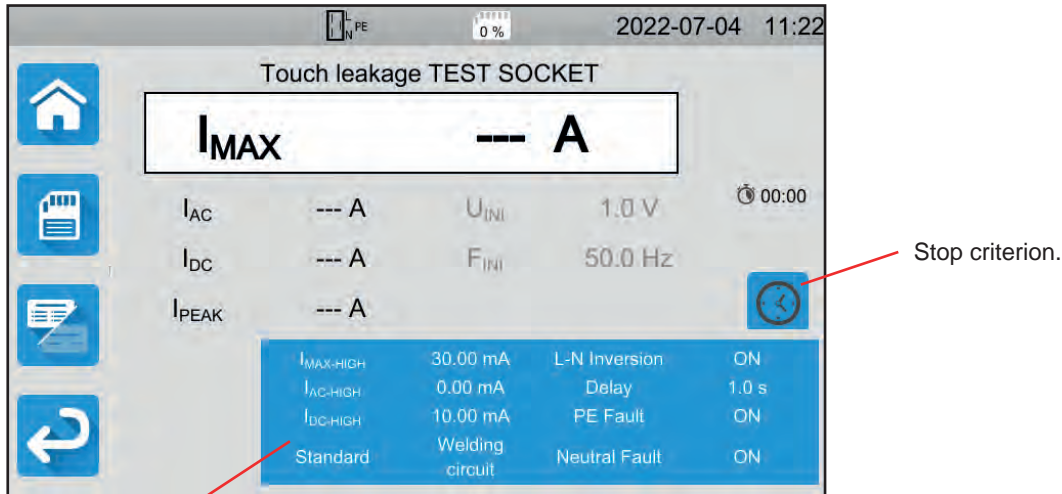





Figure 100

The parameters are in the blue rectangle. Press to modify them.

- $I_{MAX-HIGH}$ = maximum value of the contact current. You can also choose MIN for the minimum value, MAX for the maximum value. If the measurement of I_{MAX} is higher than $I_{MAX-HIGH}$, it will be declared invalid.
- $I_{AC-HIGH}$ = maximum value of the alternating contact current. You can also choose MIN for the minimum value, MAX for the maximum value. If the value of I_{AC} is higher than $I_{AC-HIGH}$, the measurement will be declared invalid.
- $I_{DC-HIGH}$ = maximum value of the direct contact current. You can also choose MIN for the minimum value, MAX for the maximum value. If the value of I_{DC} is higher than $I_{DC-HIGH}$, the measurement will be declared invalid.
- Stop Criterion: the measurement stops either automatically, or at the end of the defined duration, or manually.

You can also make this choice by pressing the  symbol:

-  the measurement will last the time required for its completion.
-  the measurement will last for the time you have programmed.
-  the measurement duration is manual. You start and stop it by pressing the **Start / Stop** button.
- Duration: duration of the measurement in seconds in the case of a measurement with a programmed duration. You can also choose MIN for the minimum time, MAX for the maximum time or OFF for automatic or manual measurement.
- Standard: contact current threshold according to IEC 60990: weighted threshold for high frequencies (Weighted for high frequency), unweighted threshold (Unweighted), threshold of perception (Weighted perception) non-release threshold (Weighted let-go).
- L-N Inversion. This inversion is required by standard IEC 60990. At the end of the measurement, after the programmed delay, a new measurement is triggered with L and N reversed.
- Delay: time that elapses between the first measurement and the measurement with L and N reversed.
- Neutral Fault: simulates a break in the neutral.
- PE Fault: simulates a break in the PE.

In the case of a measurement with a tripod cord, the following screen is displayed:

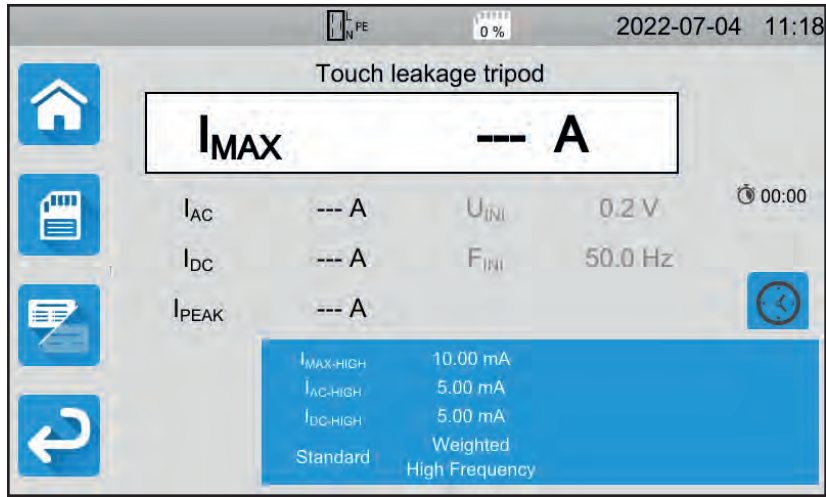
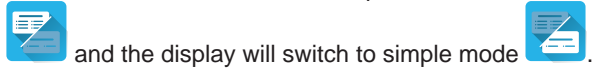

Figure 101

There are fewer parameters than in the case of a measurement on the test socket.

Shaded information is part of detailed mode. To remove them from the display, press



4.17.3. PERFORMING A CONTACT CURRENT MEASUREMENT

At the start of the measurement, the instrument checks that the contact voltage is less than 100 V. If this is not the case, it does not start the measurement.

If it is a measurement on the test socket, the machine is powered by the instrument. The **Start / Stop** button turns red for the duration of the measurement then goes out.

If it is a measurement on the test socket, the machine is no longer powered by the instrument.



4.17.4. READING THE RESULT

4.17.4.1. Example of a measurement on the test socket without inversion of L and N

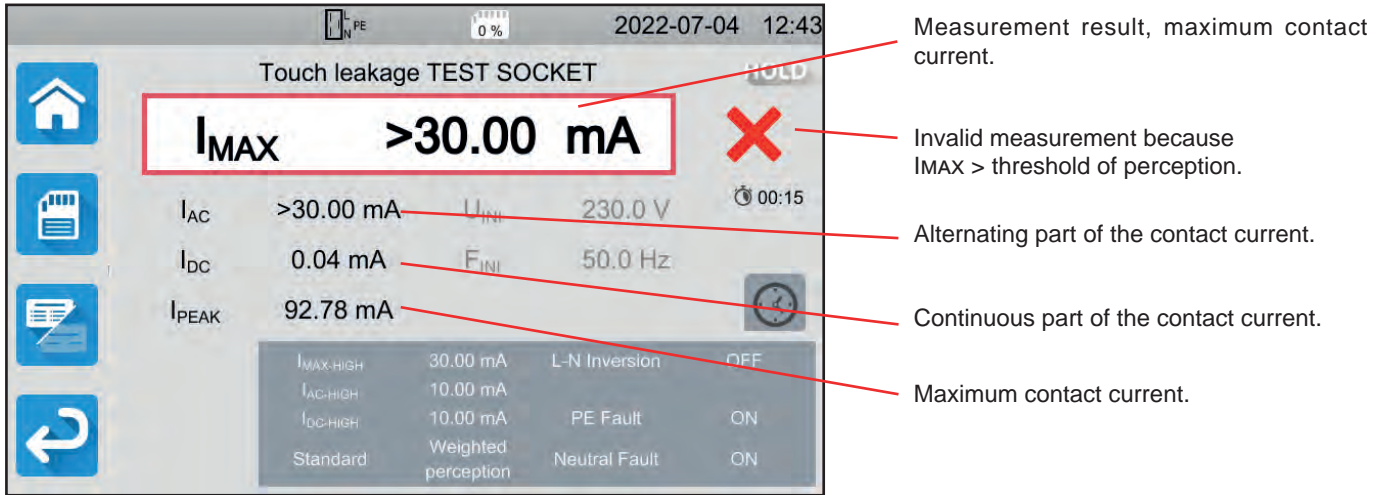

Figure 102

4.17.4.2. Example of a measurement with a tripod lead on a single-phase network

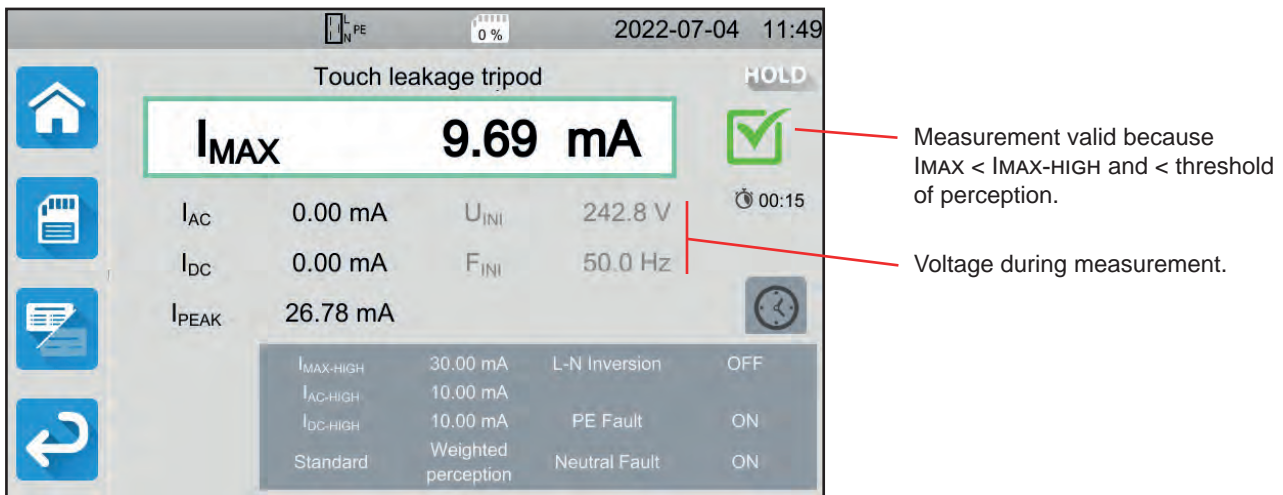

Figure 103

4.17.5. ERROR INDICATION

The most common errors in the case of a contact current measurement are:

- A mains voltage non-compliant in frequency, signal waveform, voltage level.
- A fault voltage greater than 100 V.

4.18. PHASE ROTATION

This measurement is done on a three-phase network. It makes it possible to control the order of the phases of this network.

4.18.1. DESCRIPTION OF THE MEASURING PRINCIPLE

The instrument checks the unbalance rate of the network, then it compares the phases to detect their order (forward or reverse direction).

Press the **Unit tests**  icon then **Phase rotation** .

4.18.2. CONNECTION

Use the tripod cord - 3 safety leads.

- Connect the tripod plug to terminals **L, N, PE** of the instrument.
- Connect the red lead to phase **L1** of the machine power supply.
- Connect the blue lead to phase **L2** of the machine power supply.
- Connect the green lead to phase **L3** of the machine power supply.

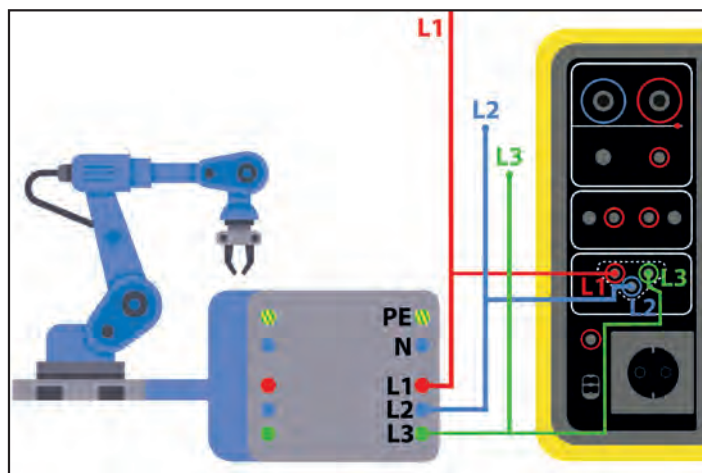

Figure 104

4.18.3. PERFORMING A MEASUREMENT

There is no configuration for this measurement.

It is not necessary to press the **Start / Stop** button to start the measurement. It remains lighted red to signify that the measurement is in progress continuously.

The result is displayed as soon as the connection is completed.

4.18.4. READING THE RESULT

4.18.4.1. Example of a phase order in the forward direction

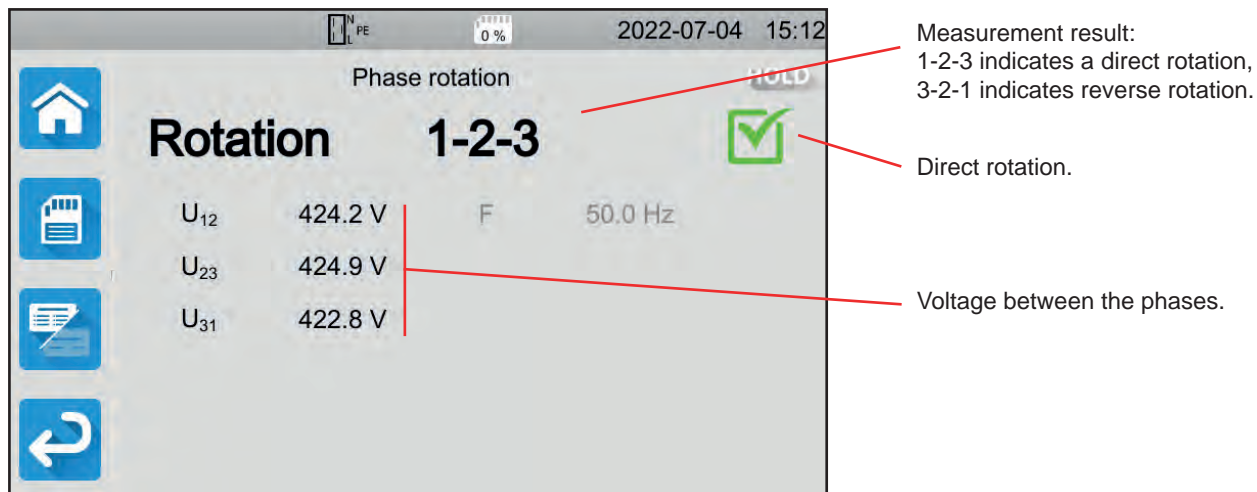

Figure 105

4.18.4.2. Example for a phase order in reverse rotation

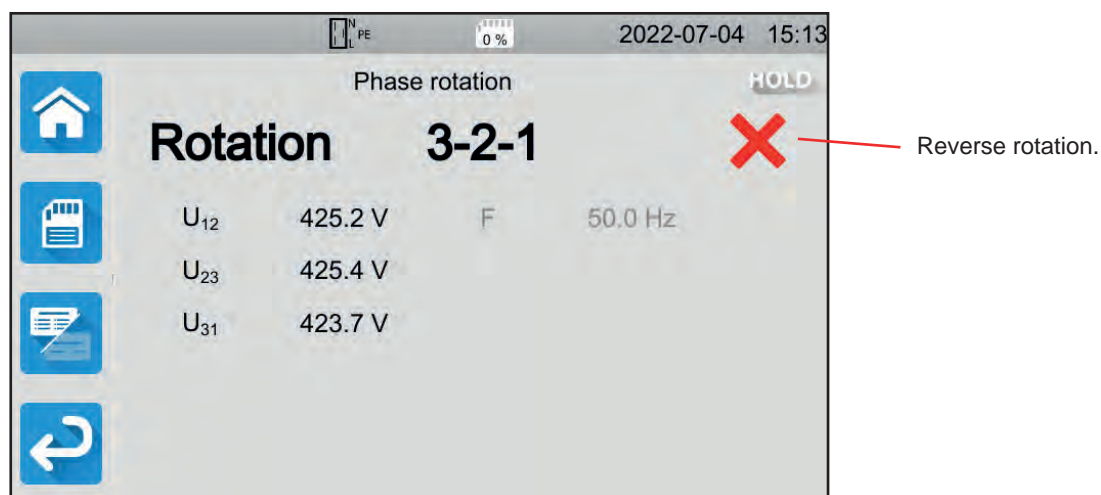

Figure 106

4.18.4.3. Example of an undetermined phase order

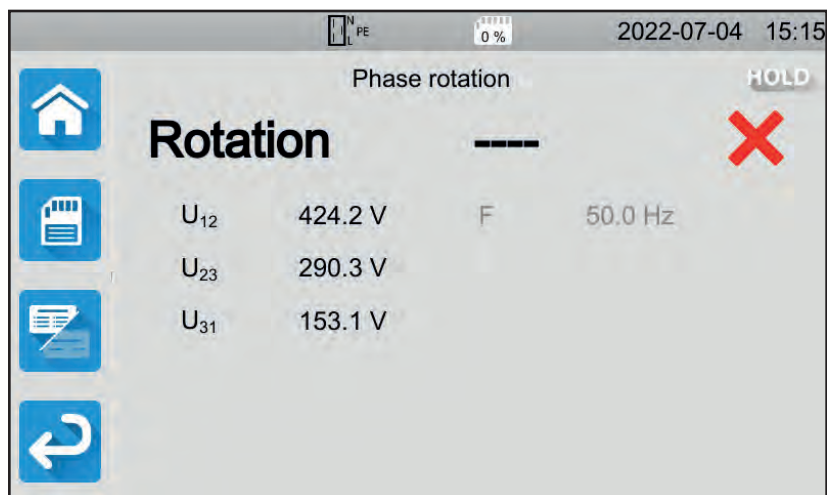

Figure 107

4.18.5. ERROR INDICATION

The most common errors in the case of a phase rotation direction test are:

- One of the three voltages is out of the measurement range (connection error).
- The frequency is out of the measurement range.
- The amplitude imbalance between the phases is too great (> 20%).

4.19. DISCHARGE TIME

This measurement makes it possible to know the discharge time due to the capacitors in the machine, from the operating voltage to a voltage that is not dangerous for the user.

Press the **Unit tests**  icon then **Discharge time** .

4.19.1. CONNECTION

4.19.1.1. Measurement via the test socket

This connection is used for a machine operating on single-phase and whose current consumption is less than 16 A.

- Choose the connection **Test socket**  then  in the setup.
- Connect the mains plug of the machine to the **TEST SOCKET** of the instrument.

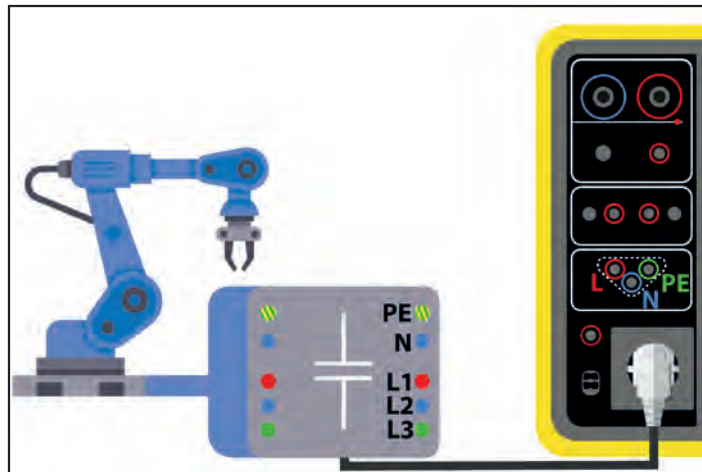



Figure 108

4.19.1.2. With the tripod socket and cord - 3 safety cords single-phase

This connection is used for a machine operating on single-phase and whose current consumption is less than 16 A, but this time it is the user who cuts the power supply to the machine.

- Choose the connection **Test socket**  then  in the setup.
- Connect the mains plug of the machine to the **TEST SOCKET** of the instrument.
- Connect the red lead to the phase of the machine power supply.
- Connect the blue lead to the neutral of the machine power supply.

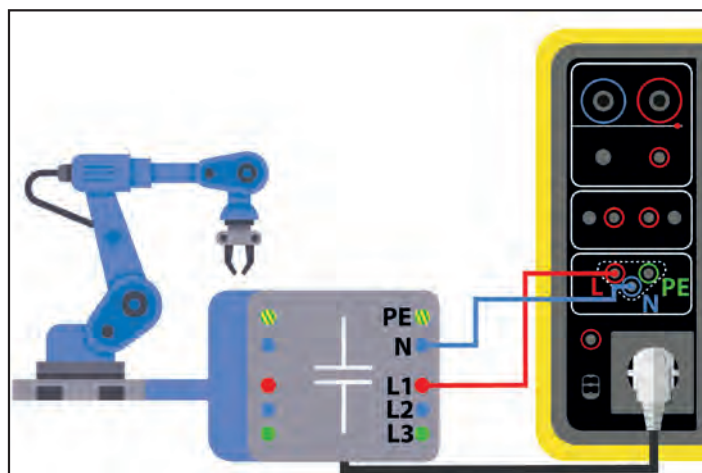

Figure 109

4.19.1.3. With the tripod cord - 3 three-phase safety leads

This connection is used for a machine operating on single-phase whose current consumption is higher than 16 A or for a machine operating on three-phase.

- Choose the **Tripod** connection.
- Connect the tripod plug to terminals **L, N, PE** of the instrument.
- Connect the red lead to one of the power supply phases of the machine.
- Connect the blue lead to the neutral of the machine power supply.
- Connect the green lead to the PE of the machine power supply.
- Connect the power supply of the machine to the mains.

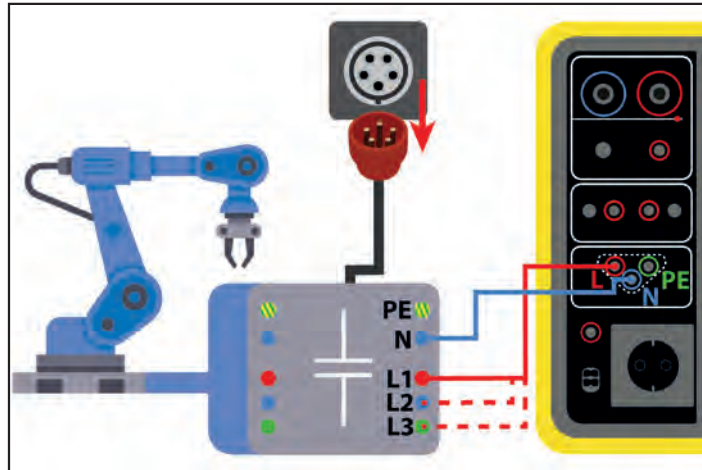

Figure 110

For the three-phase, it will be necessary to repeat the measurement on each of the phases.

4.19.2. MEASUREMENT CONFIGURATION

For a measurement on the test socket, the following screen is displayed:

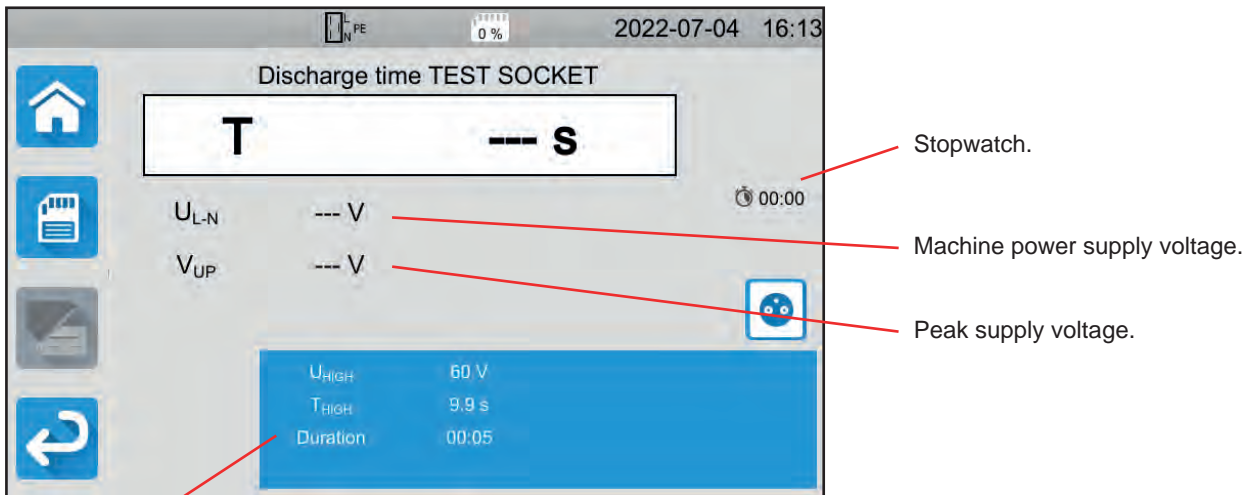

Figure 111

The parameters are in the blue rectangle. Press to modify them.

- U_{HIGH} = voltage threshold value. 34, 60 or 120 V. From this value, the stopwatch is stopped.
- Measurement: measurement on the test socket only or measured with the tripod cord.
- T_{HIGH} = maximum value of the discharge time. You can also choose MIN for the minimum value, MAX for the maximum value or OFF to give no upper limit. If the value of T is higher than T_{HIGH} , the measurement will be declared invalid.

- Duration: duration of voltage application in seconds before the power supply is cut off. You can also choose MIN for the minimum time or MAX for the maximum time.

In the case of a measurement with a tripod cord, the following screen is displayed:

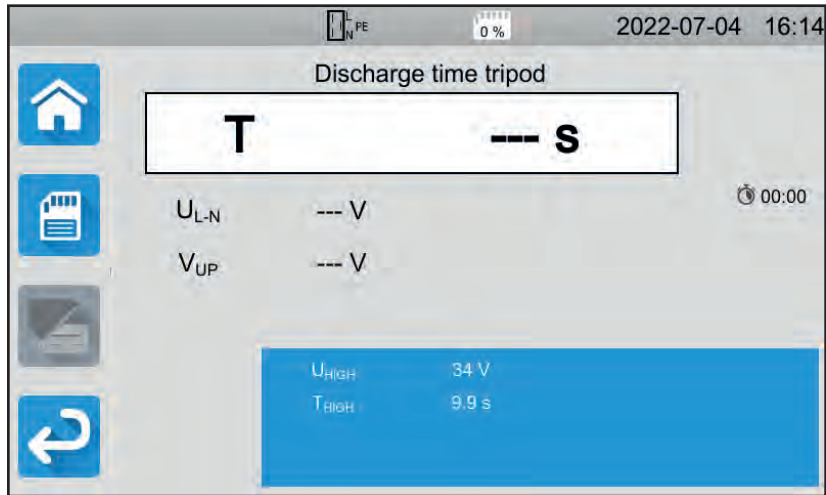

Figure 112

There is no duration since it is the user who cuts off the power.

4.19.3. PERFORMING A DISCHARGE TIME MEASUREMENT

Press the **Start / Stop** button to start the measurement.

You can only press the **Start / Stop** button when it is green. It turns red for the duration of the measurement then turns off.



For a measurement on the test socket, the instrument cuts the power supply to the machine.

For measurement with a tripod cord, the machine must be disconnected by unplugging its power plug.

4.19.4. READING THE RESULT

4.19.4.1. Example of a measurement on the test socket

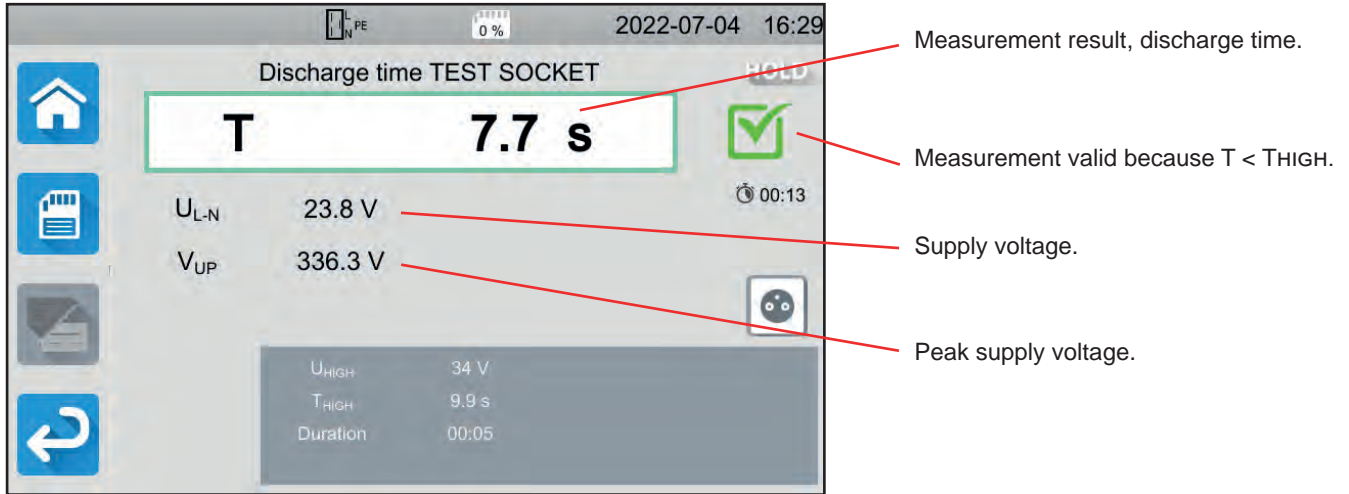

Figure 113

4.19.4.2. Example of a measurement with a tripod lead

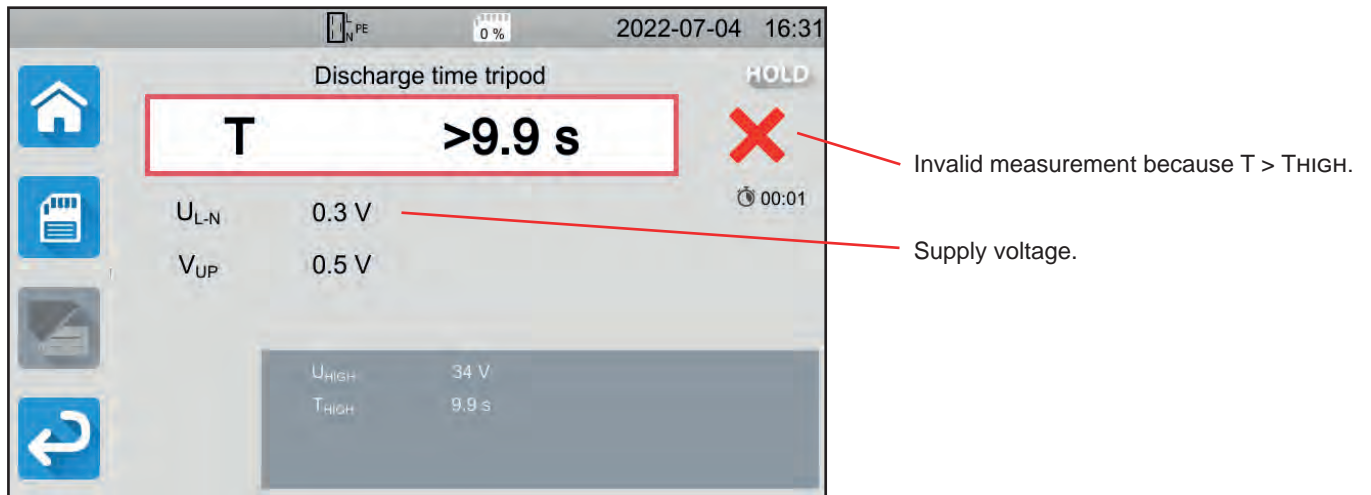

Figure 114

4.19.5. ERROR INDICATION

The most common error in a discharge time measurement is:

- A mains voltage non-compliant in frequency, signal waveform, voltage level.

4.20. AUTO SCRIPT

You can perform multiple unit tests in a row in a test sequence.
To do this, you must first programme your test sequence in the MTT software (§ 7).

In the **Instrument** menu, select **Auto Script**.

In the Auto Script you can put:

- unit tests,
- messages,
- images,
- impressions,
- loops,
- enter the password automatically (for a dielectric test),
- or save the measurement.

On the instrument, press the Auto Script icon .

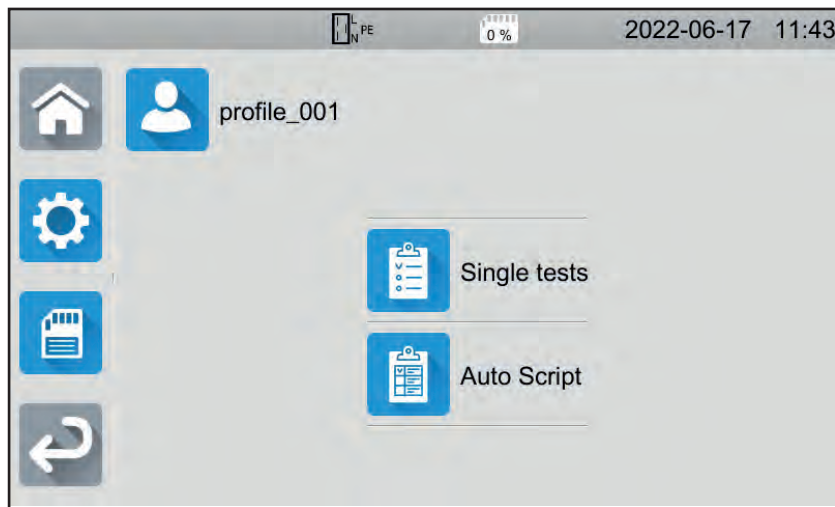

Figure 115

The instrument displays the list of available Auto Scripts.

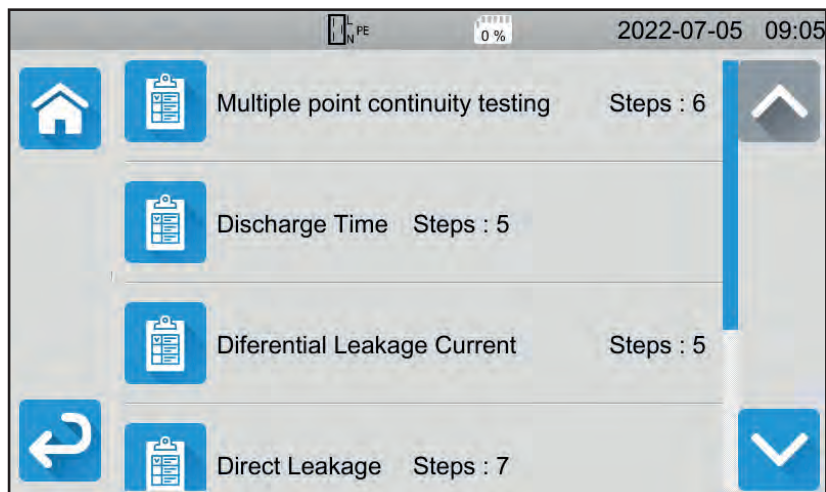

Figure 116

Choose the one you want to run. The instrument displays the details of the actions to be performed.

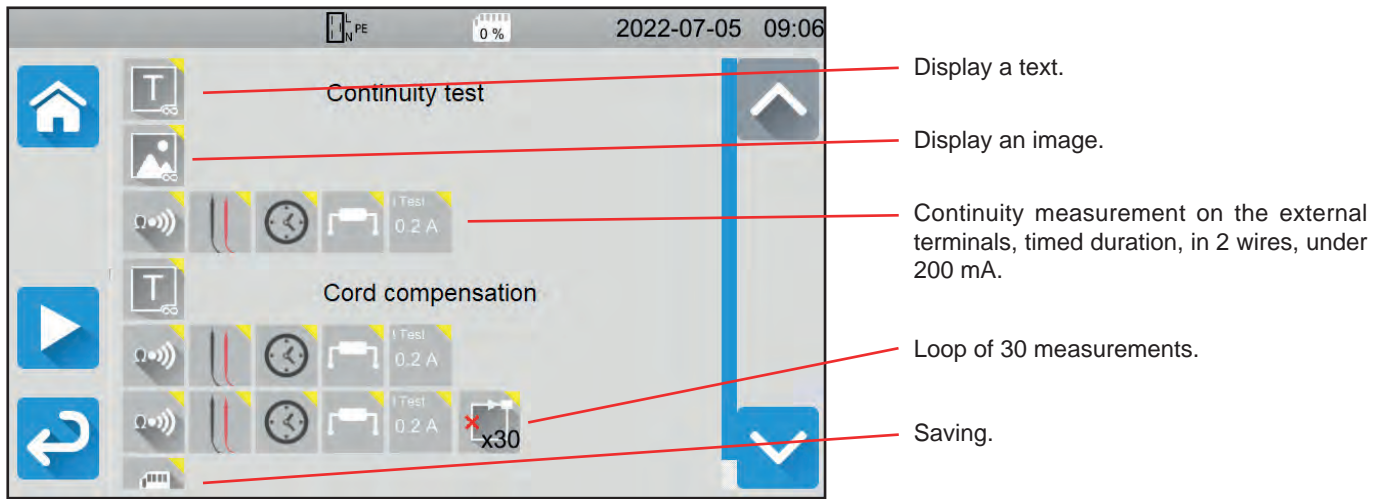



Figure 117

Press  to start the Auto Script.

The instrument asks for confirmation, then it will perform each action one after the other. For each measurement, make the connections then press the **Start / Stop** button.

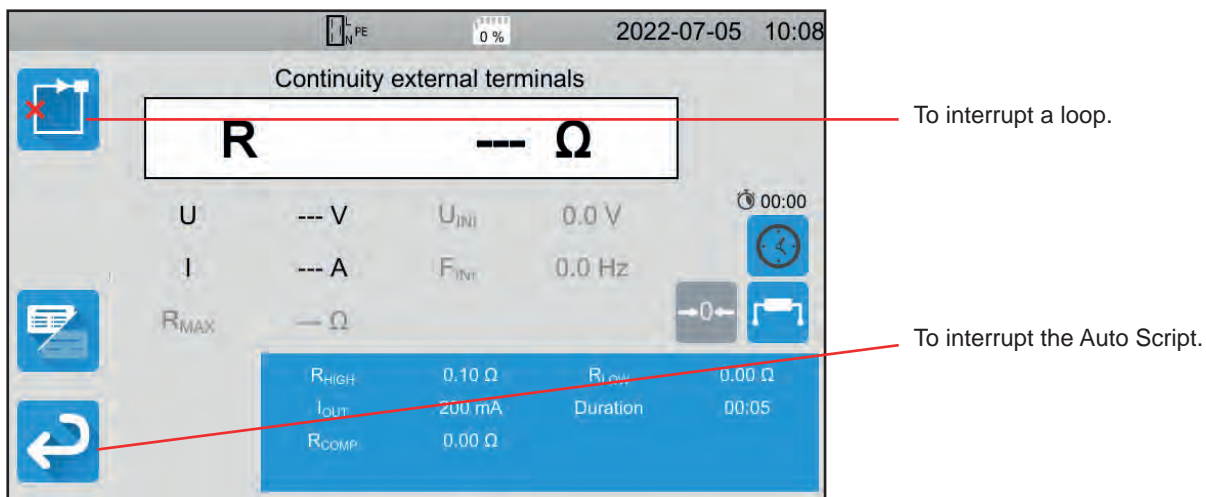

Figure 118

You can interrupt the measurements by pressing the **Start / Stop** button. You can also save them.

When all tests are complete, the instrument displays a message that the Auto Script is complete.

5. USE OF ACCESSORIES

To facilitate the use of your instrument, you have a large number of accessories at your disposal.

5.1. PRINTER

- Connect the printer to mains.
 - Connect the printer to one of the two USB ports marked . The  symbol appears in the status bar.
- At the end of each measurement, you can print it by pressing the  key.

The following screen is displayed:

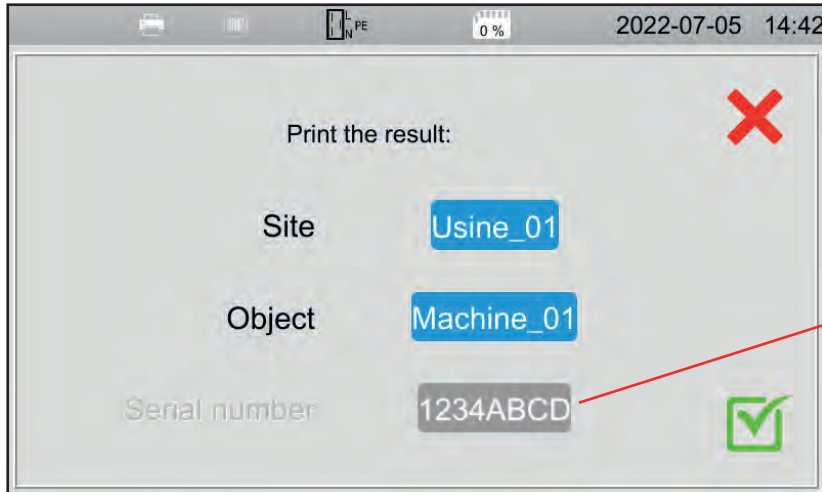



If the serial number was defined when the object was created.

Figure 119

Confirm and the printer prints a label (57 x 32 mm thermal label) in English stating:



- the date,
- the test type,
- the object,
- the serial number,
- the user's name,
- and whether the test is valid or not.

5.2. BARCODE READER

- Connect the barcode reader to one of the two USB ports marked . The  symbol appears in the status bar.

When storing a measurement or when you define an object, you can scan its barcode using the barcode reader and it will be automatically entered in the selected field.

5.3. RFID RECEIVER

- Connect the RFID receiver to one of the two USB ports marked . The  symbol appears in the status bar.



You cannot simultaneously connect the barcode reader and the RFID receiver to the instrument.

If the machine being tested has an RFID chip, you can use the RFID receiver to read the chip and communicate its reference to the instrument. This can be used when you define an object when saving measurements.

5.4. WIRING EXTENSION CONNECTORS

The accessories described in § 1.3 are ready to use.

The 3 extension connectors provided let you adapt an accessory that you already have (pedal for foot control, signal lamps tower or door closed checker) for use with the CA 6161 or the CA 6163.

- Unscrew the connector and remove the centre part.

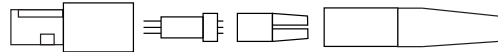

- Pass the cable through the grommet.



- Wire the central part according to the diagrams (top view) below.

No.	Description	No.	Description	No.	Description
1	Ground	1	24 Vdc	1	Ground
2	1-2 closed: identification	2	"High voltage" lamp	2	1-2 closed: door closed 1-2 open: door open
3	1-3 closed: button pressed 1-3 open: button released	3	"Ready" lamp	3	0 V
4	Not connected	4	"Success" lamp	4	3-4 closed: test in progress 3-4 open: no test in progress
		5	"Fail" lamp	5	3-5 closed: last test successful 3-5 open: no result
				6	3-6 closed: last test failed 3-6 open: no result
<p> $I_{min} = 370 \mu A$ $I_{max} = 1.2 mA$ </p>				<p> $I_{max} = 1.2 mA$ Max voltage with respect to earth 3750 V 50 Hz $I_{max} = 8.1 mA$ $V_{max} = 4 V$ </p>	

Table 2

- Assemble the central part respecting keying then screw the connector back on.

5.5. LAMP TOWER

To know the status of a measurement without having to look at the instrument's screen, you can use the lamp tower.

Plug it into the yellow connector .



The blinking red light indicates that the instrument is generating a dangerous voltage (when measuring insulation or in dielectric test). It corresponds to the instrument's  indicator.

The green light indicates that the measurement is in progress. It corresponds to the **Start / Stop** button lighted red.

The blue light indicates that the measurement is complete and valid .

The orange light indicates that the measurement is complete and invalid .

If the measurement was interrupted before the end of the programmed duration , or if no threshold has been defined, no indicator is lit.

Figure 120

5.6. PEDAL

The pedal replaces pressing the **Start / Stop** button.

Connect it to the green connector. . The symbol  is displayed on the status bar.

5.7. DOOR CHECKER

Since the dielectric tests are dangerous, you can protect the test area with a hood. The door checker is used to verify that the protection is in properly place.

For wiring, see § 5.4.

Plug it into the blue  connector.

To activate it, see § 4.10.3.

6. MEMORY FUNCTION

6.1. MEMORY ORGANISATION

The memory is organised by sites, objects, Auto Script and measurements.

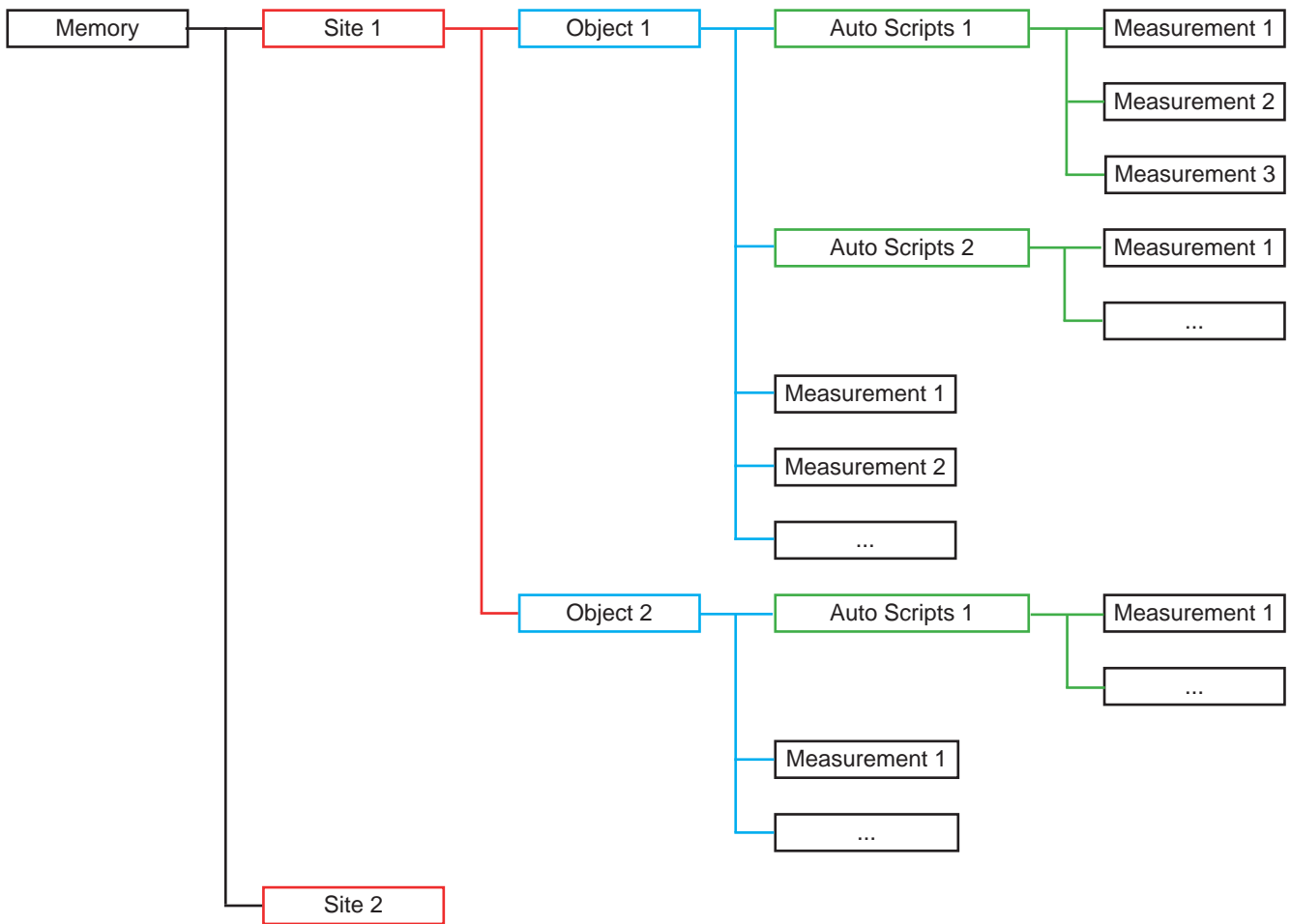

Figure 121

The instrument can save

- 100,000 measurements,
- 100 objects per site,
- 1,000 measurements or Auto Scripts per object,
- 1,000 measurements per Auto Scripts.

Beyond these limits, the instrument indicates to use the Machine Tester Transfer software.

6.2. SAVING A MEASUREMENT



At the end of each measurement, you can save it by pressing

The instrument offers to save the measurement in the last location used. You can confirm or choose a different location.

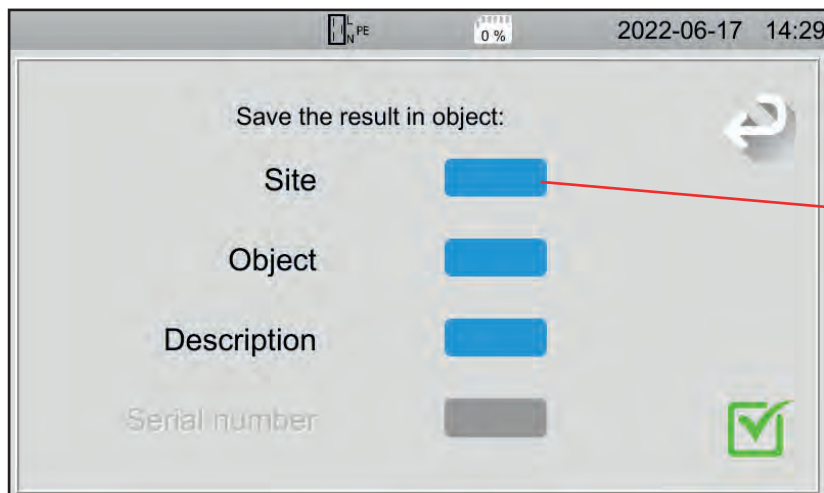

Figure 122

Press to create a site.

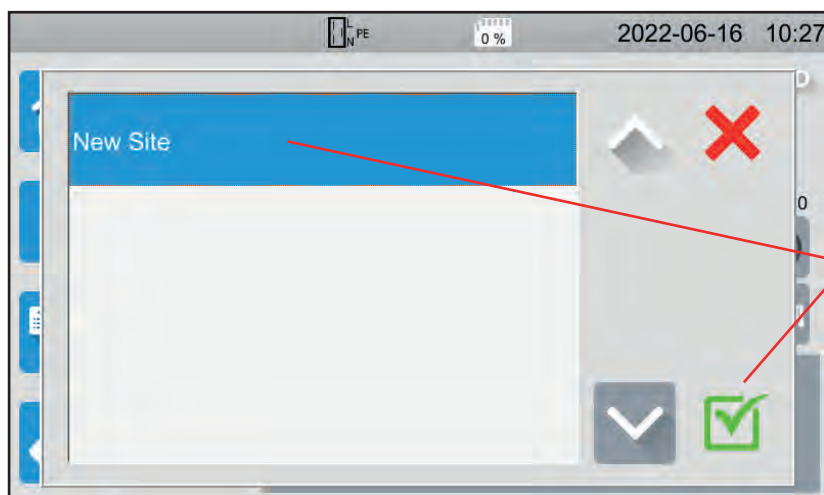

Figure 123

The instrument displays all existing sites. For now, there are none. To create a new site, press **New Site** and confirm.

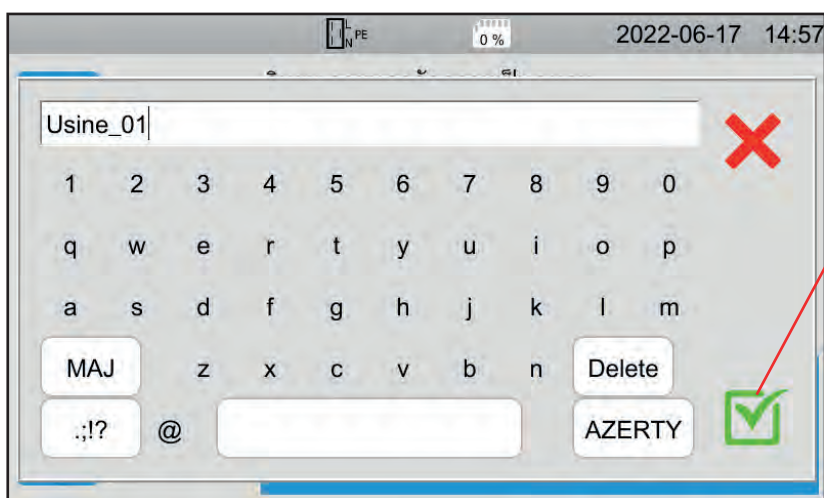

Figure 124

Using the keypad, enter the name of the site, here Plant_01 and confirm.

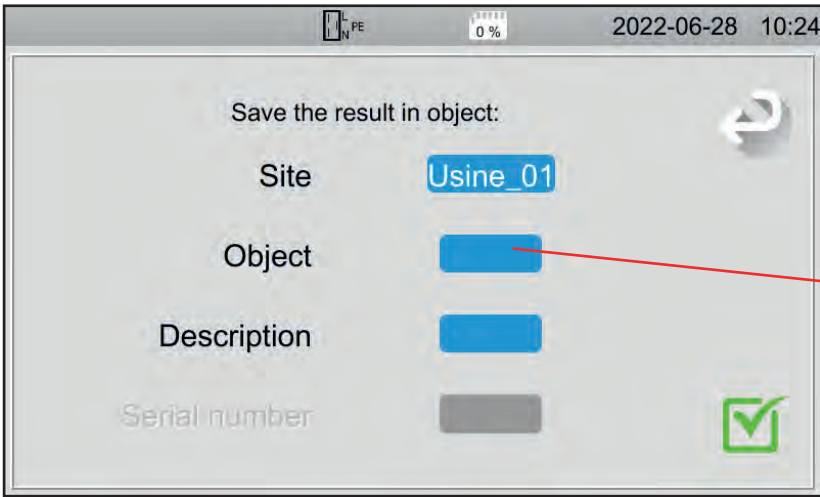

Figure 125

Press to create the object.

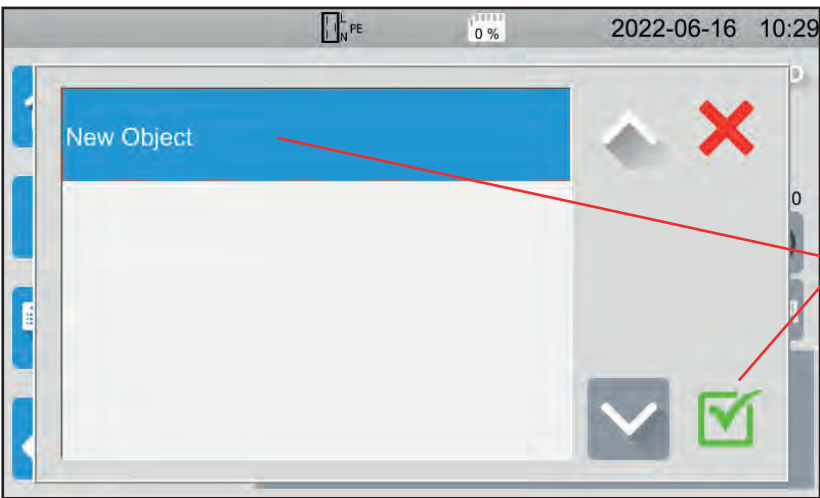

Figure 126

The instrument displays all existing objects. For now, there are none. To create a new object, press **New Object** and confirm.

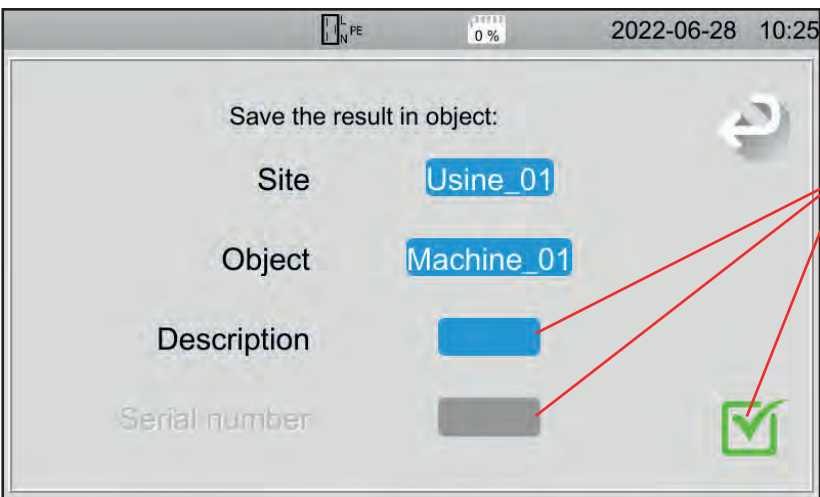

Figure 127

Enter the name of the object and confirm. Here Machine_01. You can add a description and serial number and then confirm.

- If the machine has a barcode, you can scan it using the optional barcode reader and the serial number will be automatically entered in the corresponding field.
- If the machine has an RFID chip, you can use the optional RFID receiver to fill in the corresponding field.

The measurement is saved.

The next time a measurement is saved, the instrument will offer the last Site and the last Object used. You can use them or create others.

6.3. REVIEW OF RECORDINGS

To review measurements, start from the home screen and press .

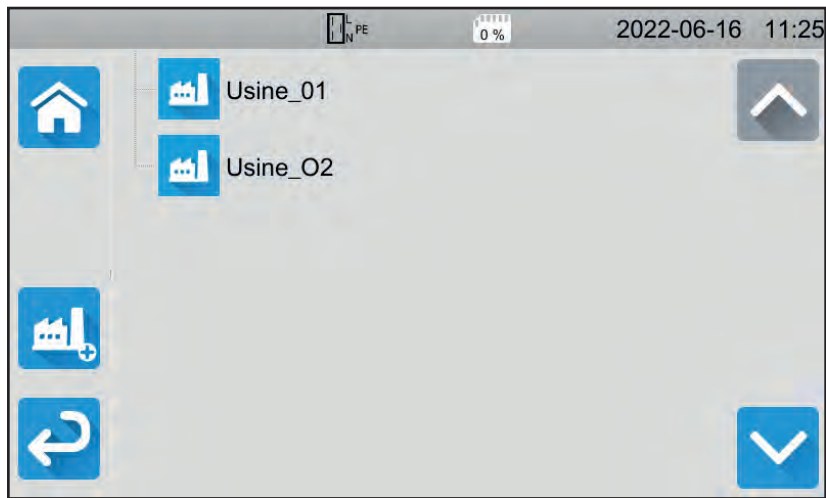

Choose the site.

Figure 128

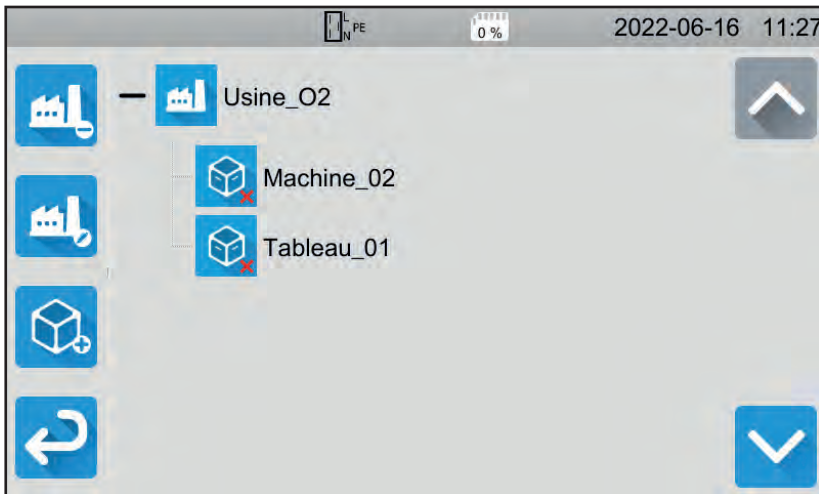

Choose the object.



- If the symbol is , then all the measurements made on this object are valid.
- If it is , at least one of the measurements is invalid.
- If it is , at least one of the measurements has been interrupted before the end.

Figure 129



Press the object to see the measurements contained in the object.

The measurements are easily identifiable by their symbol. Their validity is also indicated.

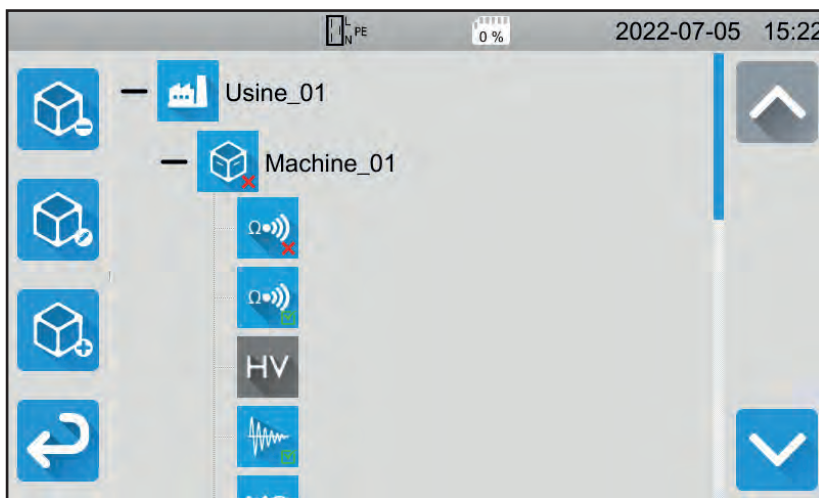

- If the symbol is , the measurement is valid.
- If it is , the measurement is invalid.
- If it is , the measurement was interrupted before the end.
- If there is no symbol, no threshold has been defined.
- If the measurement is greyed out, it was saved before it was completed.

Figure 130

To review a measurement, select it. The measurement is displayed as it was when it was saved.

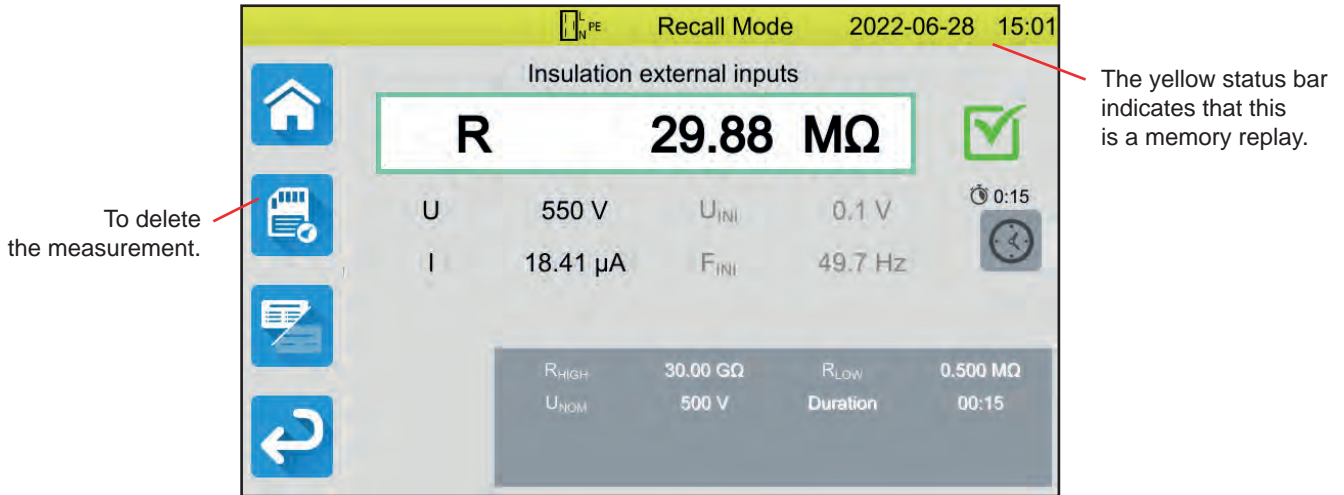









Figure 131





6.4. MEMORY MANAGEMENT

To manage memory, start from the Home screen and press .

You can:

- add a site 
- delete a site 
- edit an existing site 
- add an object 
- delete an object 
- edit an existing object 

You can edit:

- its name,
- its icon: general , machine , electrical panel ,
- its barcode,
- its RFID code,
- its serial number,
- and add a comment.
- delete a measurement .

6.5. ERRORS

When the memory is full, you can no longer save a measurement. You must then delete at least one object to be able to save your new measurement.

7. MTT APPLICATION SOFTWARE

The MTT (Machine Tester Transfer) application software allows you to:

- configure the instrument and measurements,
- start the measurements,
- programme Auto Scripts,
- transfer the data recorded in the instrument to a PC.

MTT also allows exporting the configuration to a file and importing a configuration file.

7.1. GET MTT

Download the latest version of MTT software from our website:

www.chauvin-arnoux.com

Go to the **Support** tab, then **Download our software**.

Then search on the name of your instrument.

Download the software.

7.2. INSTALL MTT

To install MTT, run the file **set-up.exe** then follow the on-screen instructions.



7.3. USING MTT

Connect the instrument to the PC using the supplied USB cable.

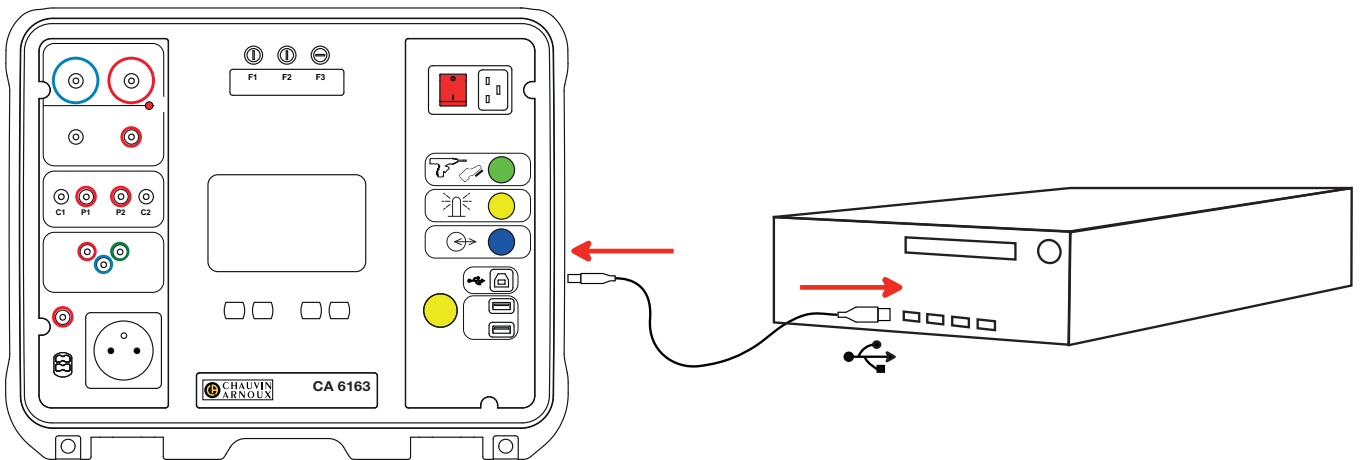

Figure 132

Turn on the instrument by pressing the **Start / Stop** switch and wait for your PC to detect it.

All measurements recorded in the instrument can be transferred to the PC. Transferring does not erase data saved in the instrument.

To use MTT, refer to its help or user manual.

8. TECHNICAL CHARACTERISTICS

8.1. GENERAL TERMS OF REFERENCE

Quantity of influence	Reference values
Temperature	23 ± 2°C
Relative humidity	45 to 75% RH
Supply voltage	230 V, 50 Hz
Electric field	≤ 1 V/m
Magnetic field	< 40 A/m

Intrinsic uncertainty is the error defined in the reference conditions. It is expressed in % of the reading (R) with an offset in number of points:

$$\pm (a \% R + b \text{ pt})$$

Operation uncertainty encompasses the intrinsic uncertainty plus the variation of the influencing quantities (supply voltage, temperature, interference, etc.) as defined in standard IEC 61557.

8.2. ELECTRICAL CHARACTERISTICS

8.2.1. FREQUENCY MEASUREMENT

Particular reference conditions:

- Sinusoidal voltage: 1 to 440 V
- AC voltage frequency: 45 to 55 Hz
- cos φ: 0.5 capacitive to 0.8 inductive
- DC Component: None

Frequency measurement

Measurement range	45.0 - 55.0 Hz
Resolution	0.1 Hz
Intrinsic uncertainty	± (2 % R + 1 pt)

8.2.2. CONTINUITY MEASUREMENT

Particular reference conditions:

- Lead resistance: zero or compensated.
- Lead inductance: zero.
- External voltage on terminals: zero.
- Inductance in series with the resistor: zero.

Lead compensation:

- up to 5 Ω for a test current of 100 or 200 mA
- up to 0.3 Ω for a test current of 10 or 25 A.

The maximum allowable superimposed external alternating voltage is 5 V in sine.

The frequency of the measurement current is that of the mains voltage which supplies the instrument.

The maximum duration of the measurement is 3 minutes (180 seconds).

Voltage measurement U, UINI

Measurement range	1.0 - 300.0 V
Resolution	0.1 V
Intrinsic uncertainty	± (3 % R + 3 pt)

Current measurement

Measurement range	0.01 - 0.99 A	0.8 - 40.00 A
Resolution	10 mA	100 mA
Intrinsic uncertainty	$\pm (3 \% R + 3 \text{ pt})$	

Continuity measurement under 100 mAac

Measurement range	0.05 - 19.99 Ω	18.0 - 120.0 Ω
Resolution	10 m Ω	100 m Ω
Intrinsic uncertainty	$\pm (2 \% R + 2 \text{ pt})$	$\pm (3 \% R + 3 \text{ pt})$
No-load voltage	> 4 VAC	
Test current	$\geq 100 \text{ mA}$ for $R < 100 \Omega$	

Continuity measurement under 200 mAac

Measurement range	0.05 - 2.00 Ω	2.01 - 19.99 Ω	18.0 - 60.0 Ω
Resolution	10 m Ω	10 m Ω	100 m Ω
Intrinsic uncertainty	$\pm (2 \% R + 2 \text{ pt})$	$\pm (2 \% R + 2 \text{ pt})$	$\pm (3 \% R + 3 \text{ pt})$
No-load voltage	> 4 VAC		
Test current	$\geq 200 \text{ mA}$ for $R < 45 \Omega$		

Continuity measurement under 10 Aac

Measurement range	0.005 - 0.500 Ω
Resolution	1 m Ω
Intrinsic uncertainty	$\pm (2 \% R + 2 \text{ pt})$
No-load voltage	> 4 VAC
Test current	$\geq 10 \text{ A}$ for $R < 1 \Omega$

Continuity measurement under 25 Aac (CA 6163)

Measurement range	0.005 - 0.400 Ω
Resolution	1 m Ω
Intrinsic uncertainty	$\pm (2 \% R + 2 \text{ pt})$
No-load voltage	> 4 VAC
Test current	$\geq 25 \text{ A}$ for $R < 0.4 \Omega$

8.2.3. INSULATION MEASUREMENT RESISTANCE

Particular reference conditions:

- Parallel capacitance: < 1 nF
- Input resistance: 8 M Ω
- Maximum permissible external AC voltage during measurement: < 1 V
- Relative humidity on the **TEST SOCKET**: $\leq 50 \%RH$

Voltage measurement U, UINI

Measurement range	0.5 - 399.9 V	380 - 1200V
Resolution	0.1 V	1 V
Intrinsic uncertainty	$\pm (1 \% R + 2 \text{ pt})$	$\pm (1 \% R + 2 \text{ pt})$

Above 1,250 V, the instrument displays: > 1250 V

Current measurement

Measurement range	0.01 - 39.99 μ A	32.0 - 399.99 μ A	0.320 - 1.500 mA	
Resolution	10 nA	100 nA	1 μ A	
Intrinsic uncertainty	$\pm (10 \% R + 3 \text{ pt})$			

Insulation measurement CA 6161

Measuring range under 100 V	0.000 - 9.999 M Ω	8.00 - 99.99 M Ω	-	-
Measuring range under 250 V	0.000 - 9.999 M Ω	8.00 - 99.99 M Ω	-	-
Measuring range under 500 V	0.000 - 9.999 M Ω	8.00 - 99.99 M Ω	80.0 - 499.9 M Ω	-
Measuring range under 1000 V	0.000 - 9.999 M Ω	8.00 - 99.99 M Ω	80.0 - 499.9 M Ω	400.0 - 1000.0 M Ω
Resolution	1 k Ω	10 k Ω	100 k Ω	100 k Ω
Intrinsic uncertainty	$\pm (2 \% R + 2 \text{ pt})$			$\pm (10 \% R + 2 \text{ pt})$

Insulation measurement CA 6163

Measuring range under 100 V	0.000 - 9.999 M Ω	8.00 - 99.99 M Ω	-	-
Measuring range under 250 V	0.000 - 9.999 M Ω	8.00 - 99.99 M Ω	-	-
Measuring range under 500 V	0.000 - 9.999 M Ω	8.00 - 99.99 M Ω	80.0 - 999.9 M Ω	0.80 - 30.00 G Ω
Measuring range under 1000 V	0.000 - 9.999 M Ω	8.00 - 99.99 M Ω	80.0 - 999.9 M Ω	0.80 - 50.00 G Ω
Resolution	1 k Ω	10 k Ω	100 k Ω	10 M Ω
Intrinsic uncertainty	$\pm (2 \% R + 2 \text{ pt})$			$\pm (10 \% R + 2 \text{ pt})$

Typical discharge time of a capacitive element to reach 25 V

Test voltage	100 V	250 V	500 V	1000 V
Discharge time (C in μ F)	1 s x C	1.5 s x C	2 s x C	2.5 s x C

Discharge resistance: 600 k Ω

Typical curve of test voltage versus load

The voltage developed as a function of the measured resistance has the following form:

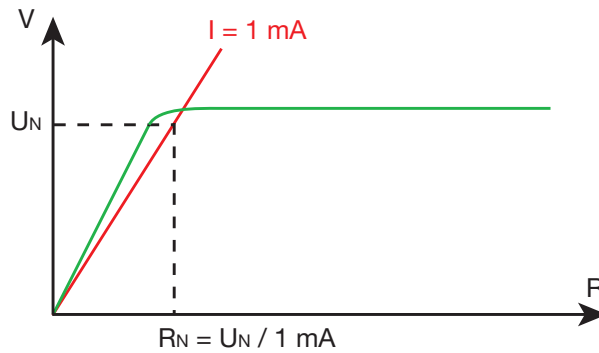

Figure 133

The maximum capacitance between the terminals is 12 μ F.

8.2.4. DIELECTRIC TEST

Voltage generator

Measurement range	100 - 3,000 V (CA 6161)	100 - 4,000 V (CA 6163)	4,010 - 5,350 V (CA 6163)
Resolution	1 V	1 V	1 V
Continuous current	100 mA	100 mA	40 mA
Maximum continuous power	300 VA	400 VA	200 VA
Maximum temporary current	< 200 mA		
Peak factor	< $\sqrt{2}$ + 3%		
Intrinsic uncertainty	$\pm (1 \% R + 2 \text{ pt})$		

Output impedance $\geq 1\text{M}\Omega$

Voltage measurement U, UINI

Measurement range	50 - 3,000 V (CA 6161)	50 - 5,350 V (CA 6163)
Resolution	1 V	1 V
Intrinsic uncertainty	$\pm (2 \% R + 2 \text{ pt})$	

For the CA 6161, above 3750 V, the instrument displays > 3750 V.

For the CA 6163, above 6250 V, the instrument displays > 6250 V.

Current measurement

Measurement range	0.5 - 99.9 mA	80 - 200 mA
Resolution	0.1 mA	1 mA
Intrinsic uncertainty	$\pm (2 \% R + 2 \text{ pt})$	

8.2.5. DIFFERENTIAL TEST (RCD)

Particular reference conditions:

Voltage UL-PE: 230VAC $\pm 0.5\%$, sinusoidal signal without harmonics.

Frequency UL-PE and UN-PE: 50 ± 0.1 Hz

Voltage UN-PE: < 1 V.

Differential current IL-N: 0 mA.

Voltage measurement UL-N, UL-PE, UN-PE

Measurement range	1.0 - 440.0 V
Resolution	0.1 V
Intrinsic uncertainty	$\pm (3 \% R + 3 \text{ pt})$

Measurement of the tripping time in pulse mode TTRIP

Measurement range	0.0 - 300.0 ms
Resolution	0.1ms
Intrinsic uncertainty	$\pm 2 \text{ ms}$
Measurement range UL-PE	200.0 - 300.0 V

Generation of the tripping current in pulse mode

mA	Without tripping		With tripping								
	0.5 I _{ΔN}	0.5 I _{ΔN}	I _{ΔN}		2 I _{ΔN}			4 I _{ΔN}	5 I _{ΔN}		10 I _{ΔN}
I _{ΔN} (mA)	AC	DC	AC	HW	AC	HW	DC	DC	AC	HW	DC
10	5	5	10	14	20	28	20	40	50	70	100
30	15	15	30	42	60	84	60	120	150	210	300
100	50	50	100	140	200	280	200	400	500	700	1000
300	150	150	300	420	600	840	600	1200	1500	-	-
500	250	250	500	700	1000	1400	1000	-	-	-	-
1000	500	500	1000	1400	-	-	-	-	-	-	-
Var [6 mA; 1000 mA]	Ivar	Ivar	Ivar	1.4 Ivar	2 Ivar 1000 max	2.8 Ivar 1400 max	2 Ivar 1000 max	4 Ivar 1200 max	5 Ivar 1500 max	7 Ivar 700 max	10 Ivar 1000 max
Type G RCD max test duration	1000 ms or 2000 ms		300ms		150ms			40ms			
Type S RCD max test duration			500ms		200ms			150ms			
Type S RCD min test duration			130ms		60ms			50 ms			
Measurement range UL-PE	90.0 - 440.0 V										
Frequency	45 - 55 Hz										
Intrinsic uncertainty of the generated current I	-(7 % I - 2 mA)		+(7 % I + 2 mA)								

Measurement of tripping current in ramp mode I_{TRIP}

I _{ΔN}	10, 30, 100, 300, 500 1000 mA
Test current	0.9573 I _{ΔN} p/28
Resolution	0.1ms
Intrinsic uncertainty	0 ... +(7 % R + 2 mA)
Measurement range UL-PE	90.0 - 440.0 V

p ∈ [9; 31]

The current ramp goes from 0.3 to 1.06 I_{ΔN} in 22 steps of 3.3% I_{ΔN}, each lasting 200 ms.

Measurement of fault voltage U_F

Measurement range	1.0 - 24.9 V	25.0 -70.0 V
Resolution	0.1 V	0.1 V
Intrinsic uncertainty	± (15% + 3 pt)	± (5% + 2 pt)

8.2.6. LOOP IMPEDANCE MEASUREMENT

Particular reference conditions:

Voltage UL-N: 230 VAC ± 0.5%, sinusoidal signal without harmonics and without continuous component.

Frequency UL-N: 50 ± 0.1 Hz

Peak factor: √2

Voltage UN-PE: zero.

Z_L < 0.1 R_s

Lead resistance: zero or compensated.

Voltage measurement U_{IN}

Measurement range	1.0 - 440.0 V
Resolution	0.1 V
Intrinsic uncertainty	± (3 % R + 3 pt)

Loop impedance measurement without tripping Zs and Rs

Measurement range	0.20 - 1.99 Ω	2.00 - 39.99 Ω	40.0 - 399.9 Ω	400 - 2,000 Ω
Resolution	10 m Ω	10 m Ω	100 m Ω	1 Ω
Intrinsic uncertainty	$\pm (15 \% R + 3 \text{ pt})$	$\pm (10 \% R + 3 \text{ pt})$	$\pm (5 \% R + 2 \text{ pt})$	$\pm (5 \% R + 2 \text{ pt})$
Measurement range UL-PE	90.0 - 440.0 V			
IL-N	$UL-N < 130 \text{ V}, IL-N = UL-N / 51.7 \Omega$ $130 \text{ V} \leq UL-N < 280 \text{ V}, IL-N = UL-N / 87.7 \Omega$ $280 \text{ V} \leq UL-N < 380 \text{ V}, IL-N = UL-N / 145.7 \Omega$ $380 \text{ V} \leq UL-N, IL-N = UL-N / 192.7 \Omega$			
IN-PE	12 mA at 7 Hz			

Loop impedance measurement with tripping Zs and Rs

Measurement range	0.005 - 0.499 Ω	0.500 - 3.999 Ω	4.00 - 39.99 Ω	40.0 - 400.0 Ω
Resolution	1 m Ω	1 m Ω	10 m Ω	100 m Ω
Intrinsic uncertainty	$\pm (10 \% R + 20 \text{ pt})$	$\pm (10 \% R + 2 \text{ pt})$	$\pm (5 \% R + 2 \text{ pt})$	$\pm (5 \% R + 2 \text{ pt})$
IL-PE	$UL-PE < 130 \text{ V}, IL-PE = UL-PE / 51.7 \Omega$ $130 \text{ V} \leq UL-PE < 280 \text{ V}, IL-PE = UL-PE / 87.7 \Omega$ $280 \text{ V} \leq UL-PE < 380 \text{ V}, IL-PE = UL-PE / 145.7 \Omega$ $380 \text{ V} \leq UL-PE, IL-PE = UL-PE / 192.7 \Omega$			

Measurement of the inductive part of the impedance Ls

Measurement range	0.1 - 15.0 mH
Resolution	0.1 mH
Intrinsic uncertainty	$\pm (10 \% R + 2 \text{ pt})$

Above 40 mH, the instrument displays > 40, mH.

If Rs > 14 Ω , then the instrument displays - - -.

The inductive part must be less than one tenth of the resistive part of the impedance, Ls < 0.1 Rs.

Short-circuit current measurement Ik

Measurement range	0 - 20,000 A
Resolution	1 A
Intrinsic uncertainty	$\pm (2 \% R + 2 \text{ pt})$

Measurement of fault voltage Uf

Measurement range	1.0 - 24.9 V	25.0 - 70.0 V
Resolution	0.1 V	0.1 V
Intrinsic uncertainty	$\pm (15\% + 3 \text{ pt})$	$\pm (5\% + 2 \text{ pt})$

8.2.7. LINE IMPEDANCE MEASUREMENT

Particular reference conditions:

Voltage UL-N: 230 VAC $\pm 0.5\%$, sinusoidal signal without harmonics and without continuous component.

Frequency UL-N: 50 ± 0.1 Hz

Peak factor: $\sqrt{2}$

Voltage UN-PE: zero.

ZL < 0.1 Rs

Lead resistance: zero or compensated.

Voltage measurement UIN

Measurement range	1.0 - 440.0 V
Resolution	0.1 V
Intrinsic uncertainty	$\pm (3 \% R + 3 \text{ pt})$

Line impedance measurement Zi, Ri

Measurement range	0.05 - 0.499 Ω	0.500 - 3.999 Ω	4.00 - 39.99 Ω	40.0 - 400.0 Ω
Resolution	1 mΩ	1 mΩ	10 mΩ	100 mΩ
Intrinsic uncertainty	± (10 % R + 20 pt)	± (10 % R + 20 pt)	± (5 % R + 2 pt)	± (5 % R + 2 pt)
Measurement range UL-N	90.0 - 440.0 V			
IL-N	UL-N < 130 V, IL-N = UL-N / 51.7 Ω 130 V ≤ UL-N < 280 V, IL-N = UL-N / 87.7 Ω 280 V ≤ UL-N < 380 V, IL-N = UL-N / 145.7 Ω 380 V ≤ UL-N, IL-N = UL-N / 192.7 Ω			

Measurement of the inductive part of the impedance Li

Measurement range	0.1 - 15.0 mH
Resolution	0.1 mH
Intrinsic uncertainty	± (10 % R + 2 pt)

Above 40 mH, the instrument displays > 40, mH.

If Rs > 14 Ω, then the instrument displays - - -.

The inductive part must be less than one tenth of the resistive part of the impedance, Li < 0.1 Ri.

Short-circuit current measurement Ik

Measurement range	0 - 100,000 A
Resolution	1 A
Intrinsic uncertainty	± (2 % R + 2 pt)

Measurement of fault voltage Uf

Measurement range	1.0 - 24.9 V	25.0 -70.0 V
Resolution	0.1 V	0.1 V
Intrinsic uncertainty	± (15% + 3 pt)	± (5% + 2 pt)

8.2.8. POWER ON THE TEST SOCKET

Particular reference conditions:

AC voltage frequency: 45 to 55 Hz

Signal waveform: sinusoidal

cos φ: 0.5 capacitive to 0.8 inductive

DC Component: None

Current measurement

Measurement range	1 - 999 mA	0.80 - 16.00 A
Resolution	1 mA	10 mA
Intrinsic uncertainty	± (3 % R + 5 pt)	

Above 16 A, the instrument displays > 16.0 A.

Active power measurement P

Measurement range	0.21 - 99.99 W	80.0 - 999.9 W	800 - 4240 W
Resolution	10 mW	100 mW	1 W
Intrinsic uncertainty	± (2 % R + 2 pt)		

Above 7000 W, the instrument displays > 7000 W.

Apparent power measurement S

Measurement range	0.21 - 99.99 VA	80.0 - 999.9 VA	800 - 4240 VA
Resolution	10 mVA	100 mVA	1 VA
Intrinsic uncertainty	± (2 % R + 2 pt)		

Above 7000 VA, the instrument displays > 7000 VA.

Voltage measurement UL-N, UL-PE, UN-PE

Measurement range	207.0 - 265.0 V
Resolution	0.1 V
Intrinsic uncertainty	± (2 % R + 2 pt)
Input impedance	450 kΩ

Voltages are measured in RMS. Only UL-N is displayed.
Above 300 V, the instrument displays > 300 V.

Measurement of cos φ

Measurement range	-1.00 to 1.00
Resolution	0.01
Intrinsic uncertainty	± (5 % R + 5 pt)

$\cos \varphi = P_1 / S_1$
with P_1 fundamental active power
 S_1 fundamental apparent power

Power factor measurement PF

Measurement range	-1.00 to 1.00
Resolution	0.01
Intrinsic uncertainty	± (5 % R + 5 pt)

$PF = P / S$
with P total active power
 S total apparent power

THD measurements

Particular reference conditions:
AC voltage frequency: 45 to 55 Hz
THDu of the voltage source: 0.0 to 8.0%
 $\cos \varphi$: 1
DC Component: None

Measurement of total harmonic voltage distortion THDu

Measurement range	0.0 - 8.0%
Resolution	0.1%
Intrinsic uncertainty	± (5 % R + 5 pt)

$$THDu = \frac{\sqrt{\sum_{n=2}^{n=25} V_n^2}}{V_1}$$

Measurement of total harmonic current distortion THDi

Measurement range	0.0 - 100.0 %
Resolution	0.1%
Intrinsic uncertainty	± (5 % R + 5 pt)

$$THDi = \frac{\sqrt{\sum_{n=2}^{n=25} I_n^2}}{I_1}$$

8.2.9. POWER ON THE TRIPOD CORD WITH THE G72 CLAMP (OPTIONAL)

The voltage is measured on the tripod socket and the current is measured by the current clamp.

Particular reference conditions:

AC voltage frequency: 45 to 55 Hz
 Signal waveform: sinusoidal
 cos φ : 0.5 capacitive to 0.8 inductive
 DC Component: None

Voltage measurement U_{1-2} , U_{2-3} , U_{3-1}

Measurement range	0.5 - 440.0 V
Resolution	0.1 V
Intrinsic uncertainty	$\pm (2 \% R + 2 \text{ pt})$

The device displays the voltage up to 500 V. Above that, the instrument displays: > 500 V.

Single-phase power measurement, measurement with the tripod lead and current clamp

Measurement range	0.05 - 99.99 W	80.0 - 999.9 W	800 - 9999 W	8.00 - 17.60 kW
Resolution	10 mW	100 mW	1 W	10 W
Intrinsic uncertainty	$\pm (2 \% R + 2 \text{ pt})$			

Above 20.00 kW, the instrument displays: > 20.00 kW.

Balanced three-phase power measurement, measurement with the tripod lead and the current clamp

Measurement range	0.05 - 99.99 W	80.0 - 999.9 W	800 - 9999 W	8.00 - 52.80 kW
Resolution	10 mW	100 mW	1 W	10 W
Intrinsic uncertainty	$\pm (2 \% R + 2 \text{ pt})$			

Above 60.00 kW, the instrument displays: > 60.00 kW.

Single-phase apparent power measurement, measurement with the tripod lead and current clamp

Measurement range	0.05 - 99.99 VA	80.0 - 999.9 VA	800 - 9999 VA	8.00 - 17.60 kVA
Resolution	10 mVA	100 mVA	1 VA	10 VA
Intrinsic uncertainty	$\pm (2 \% R + 2 \text{ pt})$			

Above 20.00 kVA, the instrument displays: > 20.00 kVA.

Apparent power measurement in balanced three-phase, measurement with the tripod lead and the current clamp

Measurement range	0.05 - 99.99 VA	80.0 - 999.9 VA	800 - 9999 VA	8.00 - 52.80 kVA
Resolution	10 mVA	100 mVA	1 VA	10 VA
Intrinsic uncertainty	$\pm (2 \% R + 2 \text{ pt})$			

Above 60.00 kVA, the instrument displays: > 60.00 kVA.

Current measurement with the G72 clamp (optional)

See § 8.2.15.

Measurement of cos φ , power factor PF

See § 8.2.8

THD measurements

Particular reference conditions:

AC voltage frequency: 45 to 55 Hz

cos φ: 1

DC Component: None

Measurement of total harmonic voltage distortion THDu

Measurement range	0.0 - 100.0 %
Resolution	0.1%
Intrinsic uncertainty	± (5 % R + 5 pt)

$$THDu = \frac{\sqrt{\sum_{n=2}^{n=25} V_n^2}}{V_1}$$

Measurement of total harmonic current distortion THDi

Measurement range	0.0 - 100.0 %
Resolution	0.1%
Intrinsic uncertainty	± (5 % R + 5 pt)

$$THDi = \frac{\sqrt{\sum_{n=2}^{n=25} I_n^2}}{I_1}$$

8.2.10. LEAKAGE CURRENT MEASUREMENT: DIRECT, DIFFERENTIAL OR BY SUBSTITUTION (CA 6163)

Particular reference conditions:

Peak factor = 2

DC component: zero

Frequency: 50 ± 0.1 Hz

Voltage measurement UL-N

Measurement range	207.0 - 265.0 V
Resolution	0.1 V
Intrinsic uncertainty	± (2 % R + 2 pt)
Input impedance	450 kΩ

Voltages are measured in RMS.

Above 300 V, the instrument displays > 300 V.

Measurement of currents IPE and IDIFF on the TEST SOCKET

Measurement range	0.01 - 30.00 mA
Resolution	0.01 mA
Intrinsic uncertainty	± (2 % R + 2 pt)

Above 50.00 mA, the instrument displays: > 50.00 mA.

Measurement of currents IPE and IDIFF with the G72 clamp

Measurement range	0.5 - 999.9 mA	0.800 - 9.999 A	8.00 - 40.00 A
Resolution	0.1 mA	1 mA	10 mA
Intrinsic uncertainty	± (2.5 % R + 3 pt)	± (2.5 % R + 2 pt)	± (2.5 % R + 2 pt)

Substitution current measurement Isubs (CA 6163)

Measurement range	0.01 - 50.00 mA
Resolution	0.01 mA
Intrinsic uncertainty	± (2 % R + 2 pt)

The measurement circuit is defined in standard IEC 90974-4

The resistance is between 1 and 2 kΩ.

8.2.11. POWER AND LEAKAGE CURRENT MEASUREMENT (CA 6163)

For power, see § 8.2.8.

For leakage current, see § 8.2.10.

For contact current, see § 8.2.12.

8.2.12. CONTACT CURRENT MEASUREMENT

Particular reference conditions:

Peak factor = 2

DC component: zero

Contact current measurement I_{MAX} , I_{AC}

Measurement range	0.01 - 30.00 mA
Resolution	0.01 mA
Intrinsic uncertainty	$\pm (2 \% R + 2 \text{ pt})$
Frequency	45 - 55 Hz

Contact current measurement I_{DC}

Measurement range	0.01 - 30.00 mA
Resolution	0.01 mA
Intrinsic uncertainty	$\pm (2 \% R + 2 \text{ pt})$

Voltage measurement U_{IN} and U

Measurement range	1.0 - 440.0 V
Resolution	0.1 V
Intrinsic uncertainty	$\pm (3 \% R + 3 \text{ pt})$

8.2.13. PHASE ROTATION DIRECTION

Particular reference conditions:

Three-phase network

Installation voltage: 190 to 440 V

Frequency: 45 to 55 Hz

Voltage waveform: sinusoidal

Imbalance rate: $\leq 20\%$.

Voltage measurement U_{1-2} , U_{2-3} , U_{3-1}

Measurement range	190.0 - 440.0 V
Resolution	0.1 V
Intrinsic uncertainty	$\pm (3 \% R + 3 \text{ pt})$

8.2.14. DISCHARGE TIME MEASUREMENT

Voltage measurement on the mains socket (TEST SOCKET) U_{IN} and U_{L-N}

Measurement range	207.0 - 265.0 V
Resolution	0.1 V
Intrinsic uncertainty	$\pm (2 \% R + 2 \text{ pt})$
Impedance of each input	27.8 M Ω

Voltages are measured in RMS. Only U_{L-N} is displayed.

Above 300 V, the instrument displays > 300 V.

Voltage measurement with tripod lead UINI and UL-N

Measurement range	1.0 - 440.0 V
Resolution	0.1 V
Intrinsic uncertainty	$\pm (3 \% R + 3 \text{ pt})$
Impedance of each input	27.8 M Ω

Voltages are measured in RMS. Only UL-N is displayed.

Discharge time measurement

Measurement range	0.1 - 9.9 s
Resolution	0.1 s
Intrinsic uncertainty	$\pm (1 \% R + 1 \text{ pt})$

Voltages are measured in RMS. Only UL-N is displayed.

8.2.15. CURRENT MEASUREMENT

Particular reference conditions:

Frequency: 45 to 55 Hz

Peak factor = $\sqrt{2}$

Voltage waveform: sinusoidal

DC component: zero

Current account imbalance rate THDi: < 4%.

Current measurement with the G72 clamp (optional)

Measurement range	0.5 - 999.9 mA	0.800 - 9.999 A	8.00 - 40.00 A
Resolution	0.1 mA	1 mA	10 mA
Intrinsic uncertainty	$\pm (2.5 \% R + 3 \text{ pt})$	$\pm (2.5 \% R + 2 \text{ pt})$	$\pm (2.5 \% R + 2 \text{ pt})$

Measurement made with 2 conductors of 6 mm² positioned in the centre of the clamp jaws.

8.3. VARIATIONS IN THE FIELD OF USE

8.3.1. INTRINSIC UNCERTAINTY AND OPERATING UNCERTAINTY

Machine and panel controllers comply with the IEC 61557 standard which requires that the operating uncertainty, called B, is less than 30%.

$$B = \pm \sqrt{A^2 + \frac{4}{3} \sum_i E_i^2}$$

The operating uncertainty is calculated for each of the functions using the terms applicable to that function.

Influences are assessed one by one.

With:

A = intrinsic uncertainty

E₁ = influence of the change of position.

E₂ = influence of the supply voltage.

E₃ = influence of the temperature.

E₄ = influence of parasitic voltage.

E₆ = influence of the phase angle.

E₇ = influence of the network frequency.

E₈ = influence of the network voltage.

E₉ = influence of network harmonics.

E₁₀ = influence of network direct current voltage.

E₁₁ = influence of the low-frequency external magnetic field.

E₁₂ = influence of the load current.

E₁₃ = influence of contact current due to common mode voltages.

E_{14} = influence of frequency.
 E_{15} = influence of repeatability.

The operating uncertainties below are only given for the measurements covered by standard IEC 61557.

8.3.2. CONTINUITY MEASUREMENT

Operating uncertainty in continuity measurement

Influence quantities	Code	Area of influence	Influence
Position of the instrument	E_1	all	0%
Supply voltage UL-N	E_2	207 ... 253 VAC	$\pm 2\%$
Temperature	E_3	0 ... 35°C	$\pm 2\%$
Operating uncertainty	B	-	$\pm 10\%$
Temperature		35 ... 45 °C	$\pm 2\% /10^\circ\text{C}$
Relative humidity		10 ... 90% RH	$\pm (1\% R + 1\text{ pt})$

8.3.3. INSULATION MEASUREMENT

Operating uncertainty in insulation measurement

Influence quantities	Code	Area of influence	Influence
Position of the instrument	E_1	all	0%
Supply voltage UL-N	E_2	207 ... 253 VAC	$\pm 2\%$
Temperature	E_3	0 ... 35°C	$\pm 2\%$
Operating uncertainty	B	-	$\pm 15\%$
Temperature		35 ... 45 °C	$\pm 2\% /10^\circ\text{C}$
Relative humidity (measurement on terminals)		10 ... 90% RH	$\pm (1\% R + 1\text{ pt})$
Relative humidity (measured on the TEST SOCKET)		10 ... 50% RH	$\pm (1\% R + 1\text{ pt})$

8.3.4. DIELECTRIC TEST

Operating uncertainty in dielectric test

Influence quantities	Code	Area of influence	Influence
Position of the instrument	E_1	all	0%
Supply voltage UL-N	E_2	207 ... 253 VAC	$\pm 2\%$
Temperature	E_3	0 ... 35°C	$\pm 2\%$
Operating uncertainty	B	-	$\pm 10\%$
Temperature		35 ... 45 °C	$\pm 2\% /10^\circ\text{C}$
Relative humidity		10 ... 90% RH	$\pm (1\% R + 1\text{ pt})$
Voltage 50/60 Hz superimposed on the test voltage U_N			$\pm (5\% R + 2\text{ pt})$
Capacitance in parallel with measured resistance		0 .. 5 μF at 1 mA 0 ... 2 μF at 2000 M Ω	$\pm (1\% R + 1\text{ pt})$ $\pm (10\% R + 5\text{ pt})$

8.3.5. DIFFERENTIAL TEST

The intrinsic uncertainty is determined under the following reference conditions:

- $V_{N-PE} < 1 \text{ V}$
- the network voltage does not vary by more than 1 V during the measurement.
- the leakage current in the network protected by the differential is negligible.
- $R_e = 100 \Omega$.

Operating uncertainty on the test current for a test with tripping

Influence quantities	Code	Area of influence	Influence
Position of the instrument	E_1	all	0%
Supply voltage UL-N	E_2	207 ... 253 VAC	$\pm 1\%$
Temperature	E_3	0 ... 35°C	$\pm 2\%$
Network voltage UL-N	E_8	207 ... 253 VAC	$\pm 1\%$
Operating uncertainty	B	-	$\pm 10\%$
Temperature		35 ... 45 °C	$\pm 2 \% /10^\circ\text{C}$
Relative humidity		10 ... 90% RH	$\pm 1\%$
Frequency of UL-N		45 ... 55 Hz	$\pm 2\%$

Operating uncertainty on the non-tripping time for a test with tripping

Influence quantities	Code	Area of influence	Influence
Position of the instrument	E_1	all	0%
Supply voltage UL-N	E_2	207 ... 253 VAC	$\pm 1\%$
Temperature	E_3	0 ... 35°C	$\pm 2\%$
Network voltage UL-N	E_8	207 ... 253 VAC	$\pm 1\%$
Operating uncertainty	B	-	$\pm 10\%$
Temperature		35 ... 45 °C	$\pm 2 \% /10^\circ\text{C}$
Relative humidity		10 ... 90% RH	$\pm 1\%$
Frequency of UL-N		45 ... 55 Hz	$\pm 2\%$

8.3.6. LOOP AND LINE IMPEDANCE MEASUREMENT

The intrinsic uncertainty is determined under the following reference conditions:

- the network on which the loop impedance measurement is carried out is under constant load conditions, with the exception of load changes caused by the measuring instrument.
- the measurements are carried out without modifying the existing loads in the network.
- the network voltage and frequency do not change by more than 0.5% during the measurement.
- the difference between the phase angle of the internal load and the loop impedance of the circuit under test is $\leq 5^\circ$.

Operating uncertainty in ground measurement RE

Influence quantities	Code	Area of influence	Influence
Position of the instrument	E ₁	all	0%
Supply voltage UL-N	E ₂	207 ... 253 VAC	± 2%
Temperature	E ₃	0 ... 35°C	± 2%
Phase angle	E ₆	0 ... 18°	
Frequency of UL-N	E ₇	47.5 ... 52.5 Hz	± 2%
Network voltage UL-N	E ₈	207 ... 253 VAC	± 2%
Harmonics of UL-N	E ₉	5 % of the 3 rd harmonic with a phase angle of 0° 6 % of the 5 th harmonic with a phase angle of 180° 5 % of the 7 th harmonic with a phase angle of 0°	± 10%
DC voltage	E ₁₀	± 1.15 V	± 5%
Operating uncertainty	B	-	± 30%
Repeatability		10 measurements spaced 10 seconds apart	± 1 pt
Parasite current IL-PE, ZL-PE = 500 Ω		0 ... 500 mA	± 5%
Parasite current IL-N, RN = 1 Ω		0 ... 10 A	± 5%
Temperature		35 ... 45 °C	± 2 % /10°C
Relative humidity		10 ... 90% RH	± (1 % R + 1 pt)

8.3.7. POWER ON THE TEST SOCKET

Influence on voltage measurement

Influence quantities	Area of influence	Influence
Temperature	0 ... 45 °C	±(0.5% R + 1pt) / 10°C
Relative humidity	10 ... 90 %RH	±(0.5% R + 1pt)
Peak factor	1.8	±(1 % R + 1pt)
Frequency	45 ... 55 Hz	±(1 % R + 1pt)
cos φ	-1 ... -0.5 capacitive and 0.8 inductive ... 1	±(1 % R + 1pt)

Influence on the frequency measurement

Influence quantities	Area of influence	Influence
Temperature	0 ... 45 °C	±(0.5% R + 1pt) / 10°C
Relative humidity	10 ... 90 %RH	±(0.5% R + 1pt)

8.3.8. LEAKAGE CURRENT MEASUREMENT WITH THE CURRENT CLAMP

The G72 clamp is class 3 according to IEC 61557-13 from 5 mA.

Operating uncertainty in leakage current measurement

Influence quantities	Code	Area of influence	Influence
Position of the instrument	E ₁	all	0%
Supply voltage UL-N	E ₂	207 ... 253 VAC	± 2%
Temperature	E ₃	0 ... 35°C	± 2%
Current harmonics	E ₉	5 % of the 3 rd harmonic with a phase angle of 0° 6 % of the 5 th harmonic with a phase angle of 180° 5 % of the 7 th harmonic with a phase angle of 0°	± 10%
External magnetic field 15 to 400 Hz	E ₁₁	Class 3 at 10 A/m from 5 mA	± 15%
Load current (for differential leakage current)	E ₁₂	Load current range	
Contact current due to common mode voltages	E ₁₃	Contact current measured via circuit A1 according to IEC 6110-1 between contact parts covered with aluminium foil and ground. The conductor is maintained at the maximum common mode voltage and the highest nominal mains frequency.	
Frequency	E ₁₄	45 ... 55 Hz	
Repeatability	E ₁₅	Difference between maximum and minimum intrinsic uncertainty	
Operating uncertainty	B	-	± 40%
Repeatability		10 measurements spaced 10 seconds apart	± 1 pt
Temperature		35 ... 45 °C	± 2 % /10°C
Relative humidity		10 ... 90% RH	± (1 % R + 1 pt)
Frequency		40 ... 100,000 Hz	

8.4. POWER SUPPLY

The instrument is powered by the mains, with a nominal voltage of 230 V ± 10% between phase and neutral.

Typical consumptions are as follows:

Function	Active power (W)	Apparent power (VA)	Current consumed (mA)
Instrument turned on without active measurement	6.8	102.2	444
Continuity (output shorted)	54.6	114.8	501
Insulation under 1000 V	8.7	102.6	447
Dielectric (output open)	22.4	132.9	573

The power supply input is protected by two fuses (F2 and F3) in the phase and in the neutral.

8.5. ENVIRONMENTAL CONDITIONS

Indoor use.

Specified operating range	0 to 45 °C and 10 to 90% RH non-condensing
Storage range	-30 to +60 °C and 10% to 90% RH non-condensing
Operating altitude	< 2,000 m
Storage altitude	< 10,000m
Degree of pollution	2

8.6. COMMUNICATION

8.6.1. WI-FI

2.4 GHz band IEEE 802.11 B/G/N radio
TX power: +18 dBm
Rx sensitivity: -97 dBm
Security: WPA2

8.6.2. USB

Type B connector
USB 2

8.7. MECHANICAL CHARACTERISTICS

Dimensions (W x D x H)	407 x 341 x 205 mm
Weight	about 16 kg for the instrument 4.8 kg approximately for the accessories delivered with the CA 6161 5.5 kg approximately for the accessories delivered with the CA 6163
Protection index	IP 64 according to IEC 60 529 cover closed. IP 40 cover open. IP 20 on the TEST SOCKET IK 08 according to IEC 62262
Drop test	0.5 m

8.8. COMPLIANCE WITH INTERNATIONAL STANDARDS

The instruments comply with IEC/EN 61010-2-034 or BS EN 61010-2-034 up to 600 V in category III depending on type of measurement.

The instruments comply with BS EN 62749 for EMF. Product intended for professional use.

The instruments comply with IEC 61557 parts 1, 2, 3, 4, 6, 7, 10 and 14.

The equipped probes and test leads comply with IEC/EN 61010-031 or BS EN 61010-031 (as required by IEC/EN 61010-2-034 or BS EN 61010-2-034).

The G72 clamp (optional) conforms to IEC/EN 61010-2-032 or BS EN 61010-2-032 (as required by IEC/EN 61010-2-034 or BS EN 61010-2-034).

The instrument + G72 clamp assembly complies with IEC 61557-13.

8.9. ELECTROMAGNETIC COMPATIBILITY (EMC)

The instrument complies with IEC/EN 61326-1 or BS EN 61326-1 for an industrial environment.

8.10. RADIO EMISSIONS

The instruments are in compliance with directive RED 2014/53/EU and with FCC regulations.
The wifi module is certified in accordance with FCC regulations under number XF6-RS9113SB.

8.11. GPL CODE

The source codes of the software under GNU GPL (General Public License) are available:
https://update.chauvin-arnoux.com/CA/CA6163/OpenSource/OpenSource_CA616X.zip

9. MAINTENANCE



Except for the fuses and the **TEST SOCKET**, the instrument does not contain any parts that can be replaced by untrained and unauthorised personnel. Any unapproved work or replacement of any part by equivalents may gravely compromise safety.

9.1. CLEANING

Disconnect anything connected to the instrument and switch it off.

Use a soft cloth, moistened with soapy water. Rinse with a damp cloth and dry rapidly with a dry cloth or forced air. Do not use alcohol, solvents, or hydrocarbons.

To clean the case, close the lid and lower the latches. The instrument is then waterproof and can be cleaned with water. Dry it before reopening the lid.

9.2. FUSE REPLACEMENT

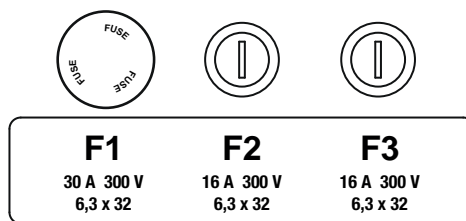





Figure 134

9.2.1. FUSE F1

Fuse F1 protects the instrument in continuity measurement with a high current (10 or 25 A).

To check F1:

- Put the instrument in continuity measurement,  then .
- Choose external connection .
- Make a short circuit by connecting a safety lead between terminals **C1** and **C2**.
- For configuration, choose a measuring current of 10 A and a measurement of 2 wires .
- Press the **Start / Stop** button to start the measurement.

If current I is close to 0, fuse F1 is faulty.

9.2.2. FUSES F2 AND F3

Fuses F2 and F3 protect the instrument's power supply.

To check F2 and F3:

- Connect the mains lead between the instrument socket and the mains.
- Press the **On / Off** switch. The instrument starts.

If the instrument does not start, one of the two fuses F2 or F3, or both fuses are defective. Either way, replace both fuses.

9.2.3. REPLACEMENT PROCEDURE

- Disconnect anything connected to the instrument and switch it off.
- For F1, press the fuse holder while unscrewing it a quarter turn.
- For F2 and F3, unscrew the fuse holder a quarter turn using a flat screwdriver.

- Remove the defective fuse and replace it with a new fuse.

 To ensure continuity of safety, replace a defective fuse only with a fuse with strictly identical characteristics.

F1: FF 30 A 300V 6.3 x 32mm

F2 and F3: FF 16 A 300V 6.3 x 32mm

- Close the fuse holder by tightening it a quarter turn. For F1, press while tightening.
- Check the correct operation of the replaced fuse as described above in § 9.2.1 or § 9.2.2.

9.3. REPLACEMENT OF THE TEST SOCKET

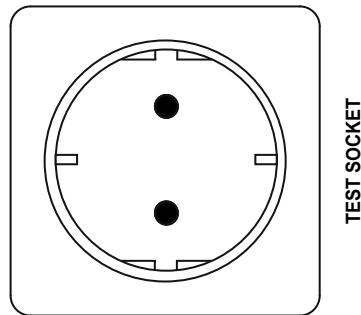

Figure 135

The **TEST SOCKET** on the front of the instrument can be replaced by another socket adapted to the electricity grid of your country.

- Disconnect anything connected to the instrument and switch it off.
- Using a flat screwdriver, remove the cover from the socket. Slide the screwdriver into the notch and lift the cover by levering it up.

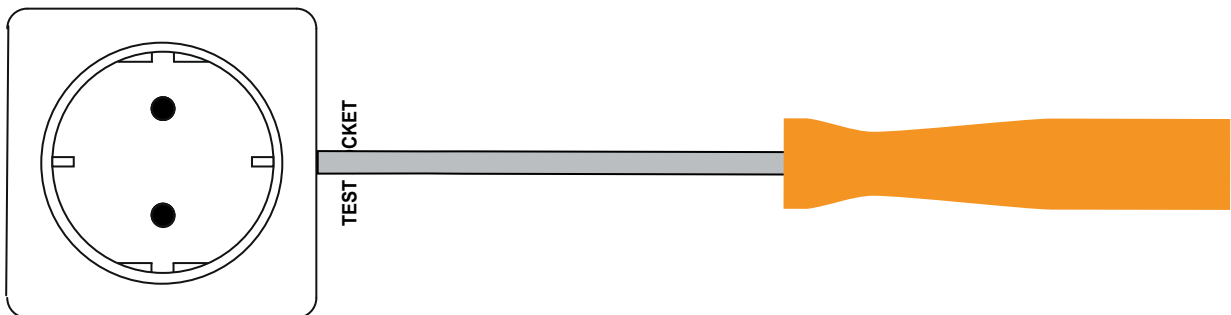

Figure 136

- Unscrew the 4 screws and remove the socket from its housing.

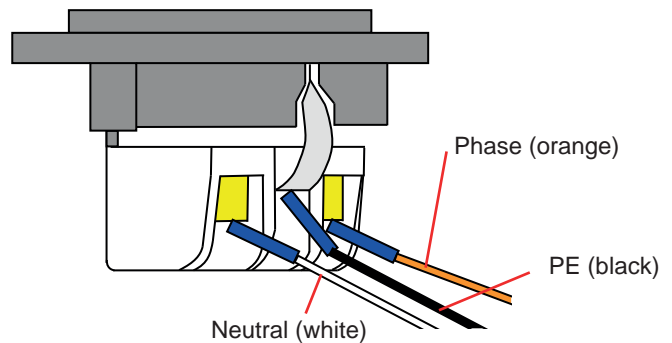
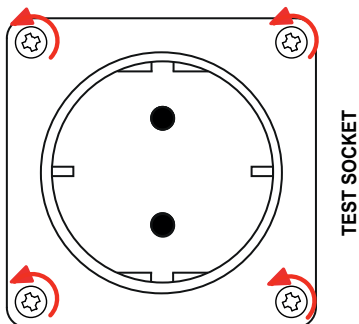

Figure 137

- Unscrew the 3 screws that hold the 3 fork lugs.
- Disconnect the 3 cables.
- Connect the 3 cables to the new socket, respecting the wiring of the phase, neutral and protective conductor. Be sure to tighten the screws enough to get good contact.

- Place the new socket in its housing.
- Tighten the 4 screws.
- Replace the socket cover.

To order the correct socket for your country, contact your distributor.

9.4. STORING THE INSTRUMENT

When the instrument is turned off, its internal clock continues to run for one month. After long-term storage, it may be necessary to update the date and time.

9.5. RESETTING THE INSTRUMENT

If the instrument freezes, turn it off by pressing the **On / Off** switch. Wait a few seconds and then turn it back on.

9.6. UPDATING THE EMBEDDED SOFTWARE

In a constant concern to provide the best possible service in terms of performance and technical developments, Chauvin Arnoux offers you the possibility of updating the software integrated into this instrument by downloading the new version free of charge from our website.

Our site:

www.chauvin-arnoux.com

In the **Support** heading, click on **Download our software** and enter the instrument name.

Firmware update depends on its compatibility with the instrument's hardware version. This version is given in the instrument configuration (see § 3.5).



Updating the firmware will erase all configuration and recorded measurements. As a precaution, back up the data in memory on a PC before updating the firmware.

Unzip the downloaded file, you get a .swu file.

To update the instrument, you have two options:

- use the MTT application software,
- or use an USB key.

In the first case, launch MTT, connect your instrument, go to the **Help** menu then **Update** and follow the procedure indicated.

In the second case, copy the .swu file to a USB key. Plug the USB key into the instrument. Press the **Start / Stop** button while turning the instrument on.

In both cases, the instrument starts in a special mode.



Figure 138

Then it starts the update. It tells you that it is in progress and that you should not turn off the instrument.



Figure 139

The update takes several minutes and then the instrument signals that it is complete. Restart it.



Figure 140

In the event of an error, the instrument reports it.



Figure 141

Repeat the update procedure. If there is a new error, contact customer service or your dealer.

9.7. CALIBRATING THE INSTRUMENT

Calibration must be carried out by qualified personnel. It is recommended to do this once a year. This operation is not covered by the warranty.

9.7.1. EQUIPMENT REQUIRED

- An AC voltage generator capable of generating 10 and 50 V at 50 Hz, accuracy 0.1%
- An AC voltage generator capable of generating 10 V and 100 mA at 45 Hz and 65 Hz, accuracy 0.1%
- A DC voltage generator capable of generating 0, 50, 100, 250, 500 and 1000 V, accuracy 0.1%
- A DC voltage generator capable of generating 102.33 V, 106, 298 V, accuracy 0.1%
- An AC generator capable of generating 1.5, 10, 20, 100 and 200 mA at 50 Hz, accuracy 0.1%
- An AC generator 5 A at 50 Hz, accuracy 0.1%
- Three resistors of 5.6 kΩ, 100 kΩ and 20 MΩ, accuracy 0.1%

9.7.2. CALIBRATION PROCEDURE



To access the calibration procedure, press  then  **About**.



Figure 142

Three new menus have appeared: ,  and  **Calibration**.

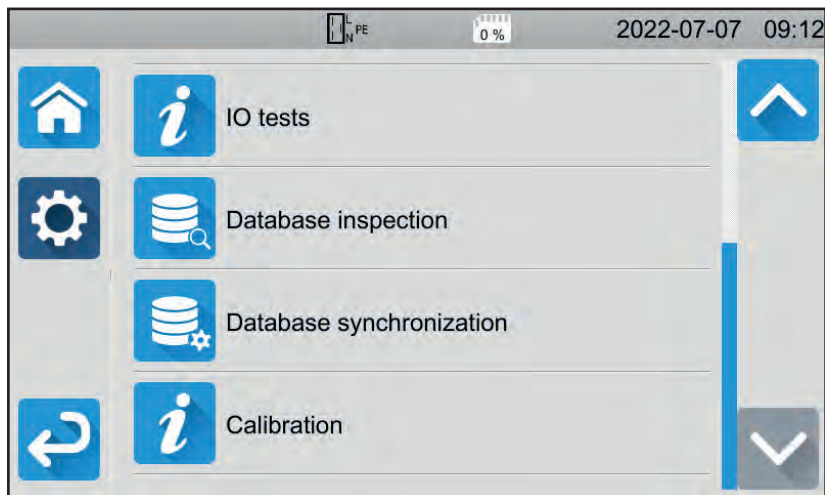

Figure 143

Press **Calibration** then enter the password: adjust@9876.



You can choose to:

- Consult the date of the last calibration.
- Restore the original calibration
- Calibrate the instrument, step by step.

Figure 144

Press **Calibration steps**.



Figure 145

Press the first step.

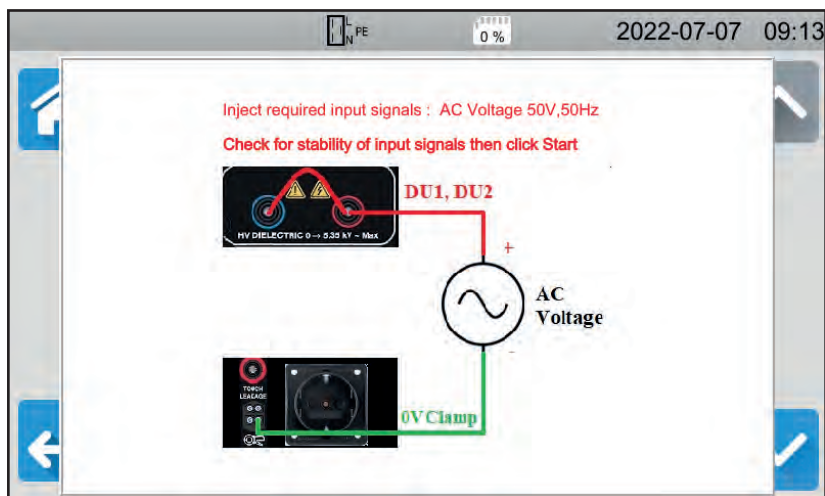

Figure 146



- Make the requested connection.
- Press the **Start / Stop** button. The instrument makes the first calibration and returns to the previous screen indicating whether the step has been confirmed  or not .
- Disconnect the instrument before proceeding to the next step.



Figure 147

Do this for the 35 steps of the calibration.

Some steps require completely disconnecting the instrument. Comply scrupulously with what is requested.

You can repeat the same step several times.

Follow the order of the steps because some steps depend on the previous steps.

If in doubt, you can reset the calibration coefficients.

At the end of the calibration, check that the date of the last calibration has been changed, then switch off your instrument.

9.8. MEMORY CHECK

When you have brought up the 3 hidden menus to calibrate the instrument, you can check and repair the database.



To check the database.

If the instrument shuts down while recording a measurement, it can corrupt the database. You then run the risk of encountering a malfunction when rereading the saved measurements. Run a diagnostic and the instrument will tell you if a repair is necessary.



To repair the database.

To be used when the instrument has advised you to do so during the diagnosis.

10. WARRANTY

Except as otherwise stated, our warranty is valid for **24 months** starting from the date on which the equipment was sold. The extract from our General Terms of Sale is available on our website.

www.chauvin-arnoux.com/en/general-terms-of-sale

The warranty does not apply in the following cases:

- inappropriate use of the equipment or use with incompatible equipment;
- modifications made to the equipment without the explicit permission of the manufacturer's technical staff;
- work done on the instrument by a person not approved by the manufacturer;
- adaptation to a particular application not anticipated in the definition of the equipment or by the user manual;
- Damage caused by shocks, falls, or floods.

11. APPENDIX

11.1. DEFINITION OF SYMBOLS

Here is the list of symbols used in this document and on the instrument display.

✓	test valid.
✗	test invalid.
○	measurement was interrupted before the end of the programmed duration or no threshold has been defined.
ΔU-TEST	maximum value of the voltage according to the cross-sectional area of the cable for continuity measurements under 10 A.
AC	alternating current signal.
C1, C2	continuity current generation terminals.
cosφ	cosine of the phase shift of the voltage with respect to the current.
DC	direct current signal.
RCD	acronym for a Residual Current Differential device
F	signal frequency.
FINI	frequency of the voltage on the terminals of the instrument before starting the measurement.
FL-PE	frequency of voltage UL-PE.
G	general type differential circuit breaker.
Hz	Hertz, unit of frequency.
I	current.
IHIGH	high current threshold.
ILOW	low current threshold.
I_{ΔN}	rated operating current of the RCD.
IAC	AC part of the contact current.
IAC-HIGH	upper threshold of the AC part of the contact current.
IDC	DC part of the contact current.
IDC HIGH	upper threshold of the DC part of the contact current.
IDIFF	differential leakage current.
IDIFF-HIGH	high threshold of the differential leakage current.
IDIFF-LOW	low threshold of the differential leakage current.
I_k	short-circuit current between terminals L and N.
I_k-HIGH	high threshold of the short-circuit current.
IFACTOR	multiplication factor of I _{ΔN} for the differential test.
IMAX	maximum value of the current during the dielectric test.
IMAX	maximum contact current.
IOUT	current measurement in continuity.
IPE	direct leakage current.
IPE-HIGH	high threshold of the direct leakage current.
IPE-LOW	low threshold of direct leakage current.
I_{SC}	current that the fuse can withstand before it blows.
I_{SC}-HIGH	maximum current supported.
ISUBS	Leakage current by substitution.
ISUBS-HIGH	high threshold of leakage current by substitution.
ISUBS-LOW	low threshold of leakage current by substitution.
IT	type of earth connection defined in standard IEC 60364-6.
ITEST	test current in loop or line impedance measurement.
ITOUCH	contact current.
ITOUCH-HIGH	high threshold of the contact current.
I_{trip}	RCD tripping current value.
L	L terminal (phase).
L1, L2, L3	phases in a three-phase network.

LI	inductive part of line impedance Zl.
Ls	inductive part of loop impedance Zs.
N	N terminal (neutral).
φ	phase shift of current with respect to voltage.
P	active power $P = U \cdot I \cdot PF$.
P1, P2	continuity voltage measurement terminals.
PE	protective conductor.
PF	power factor (cos φ in a sinusoidal signal).
PHIGH	high threshold of active power.
PLow	low threshold of active power.
R	resistance.
RCD	acronym designating a Residual Current Device
RCOMP	measurement lead compensation resistance.
RE	earth resistance.
RHIGH	high resistance threshold (continuity, insulation).
RI	resistive part of line impedance Zi.
RLOW	low resistance threshold (continuity, insulation).
RMAX	maximum value of resistance during the measurement.
RMS	Root Mean Square: effective value of the signal obtained by calculating the square root of the mean value of the square of the signal.
Rs	resistive part of loop impedance Zs.
S	selective type differential circuit breaker.
S	apparent power $S = U \cdot I$.
SHIGH	upper threshold of apparent power.
SLOW	low threshold of apparent power.
THDi	total harmonic distortion current.
THDu	total harmonic distortion voltage.
THIGH	maximum value of the discharge time.
TN	type of earth connection defined in standard IEC 60364-6.
TRAMP-DOWN	duration of voltage fall between UNOM and 0 in dielectric test.
TRAMP-UP	duration of voltage rise between USTART and UNOM in dielectric test.
TT	type of earth connection defined in standard IEC 60364-6.
TTEST	duration during which the voltage UNOM is applied. It can range from 1 to 180 seconds.
Ttrip	value of the differential tripping time.
U	voltage
U₁₂	voltage between phases 1 and 2 of a three-phase network.
U₂₃	voltage between phases 2 and 3 of a three-phase network.
U₃₁	voltage between phases 3 and 1 of a three-phase network.
Uc	contact voltage appearing between conductive parts when they are touched simultaneously by a person or an animal (IEC 61557).
UF	fault voltage appearing during a fault condition between accessible conductive parts (and/or external conductive parts) and the reference ground (IEC 61557). $UF = I_k \times Z_A$ or $UF = I_{\Delta N} \times R_E$
UHIGH	voltage threshold for discharge time.
UINI	voltage on the terminals of the instrument before the start of the measurement.
UL	maximum value of the contact voltage which can be continuously applied under the specified conditions of external influence, 50 VAC or 120VDC without ripple (IEC 61557).
UL-N	voltage measured between terminals L and N.
UL-PE	voltage measured between terminals L and PE.
UNOM	nominal test voltage generated by the instrument (insulation, dielectric).
UN-PE	voltage measured between terminals N and PE.
USTART	voltage value from which the rising voltage ramp begins in dielectric test.
V	Volt, unit of voltage.
VUP	peak supply voltage.

Z_I	line impedance. It is the impedance in the loop between phase and neutral or between two phases (line loop impedance).
Z_{I-HIGH}	high threshold of line impedance.
Z_{L-N}	impedance in the L-N loop.
Z_{L-PE}	impedance in the L-PE loop.
Z_s	impedance in the loop between the phase and the protective conductor.
Z_{s-HIGH}	high impedance threshold in the loop.

11.2. EARTH CONNECTION DIAGRAMS

11.2.1. TT NETWORK

The neutral is connected to earth and the masses of the installation are connected to earth.

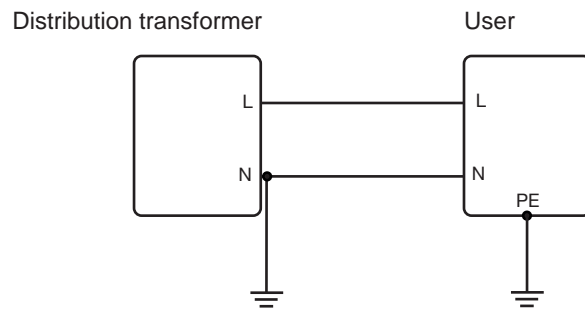

11.2.2. TN NETWORK

The neutral is connected to earth and the masses of the installation are connected to neutral.

There are 2 TN schemes:

- TN-C where the neutral and protective conductors are combined.
- TN-S where the neutral and protective conductors are separated.

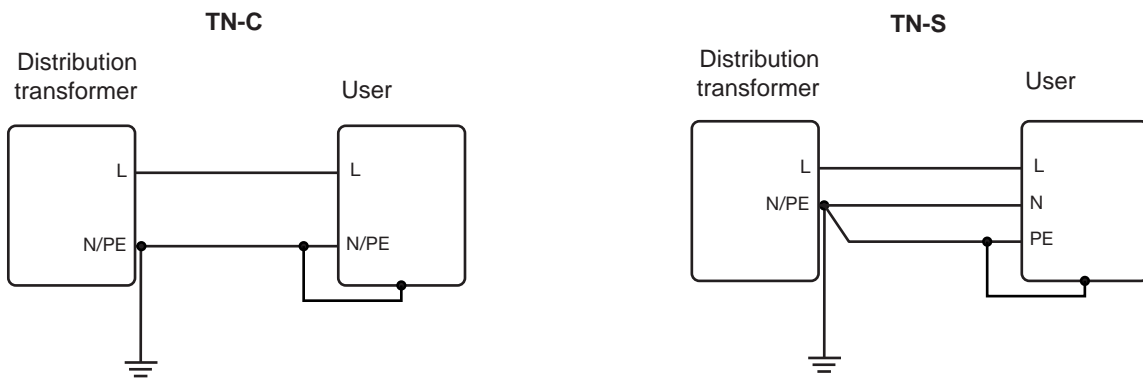

11.2.3. IT NETWORK

The neutral is insulated or impedant and the masses of the installation are earthed.

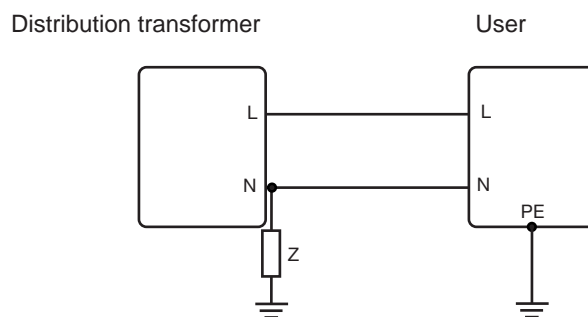

11.3. FUSE TABLE

According to standard EN60227-1 § 5.6.3

DIN gG according to standards IEC60269-1, IEC60269-2 and DIN VDE 0636-1/2

I_{ks}: breaking current for a given time (breaking time indicated for each table)

11.3.1. BREAK TIME = 5 s

Nominal current I _N (A)	Delayed fuse I _{ks} max (A)	DIN gG/gL fuse I _{ks} max (A)	RCD LS-B I _{ks} max (A)	RCD LS-C I _{ks} max (A)	RCD LS-D I _{ks} max (A)
2		6	10	20	20
4		19	20	40	40
6	21	28	30	60	60
8		35			
10	38	47	50	80	100
13		55	65	90	100
16	60	65	80	100	110
20	75	85	100	150	150
25	100	110	125	170	170
32	150	150	160	220	220
35	150	173	175	228	228
40	160	190	200	250	250
50	220	250	250	300	300
63	280	320	315	500	500
80	380	425	400	500	520
100	480	580	500	600	650
125		715	625	750	820
160		950			
200		1250			
250		1650			
315		2200			
400		2840			
500		3800			
630		5100			
800		7000			
1000		9500			
1250					

11.3.2. BREAKING TIME = 400 ms

Nominal current I_N (A)	Delayed fuse I _{ks} max (A)	DIN gG/gL fuse I _{ks} max (A)	RCD LS-B I _{ks} max (A)	RCD LS-C I _{ks} max (A)	RCD LS-D I _{ks} max (A)
2		6	10	20	20
4		19	20	40	40
6	34	46	30	60	120
8					
10	55	81	50	100	200
13		100	65	130	260
16	80	107	80	160	320
20	120	146	100	200	400
25	160	180	125	250	500
32	240	272	160	320	640
35	240	309	160	320	640
40	280	319	200	400	800
50	350	464	250	500	1000
63	510	545	315	630	1260
80		837			
100		1018			
125		1455			
160		1678			
200		2530			
250		2918			
315		4096			
400		5451			
500		7516			
630		9371			
800					

11.3.3. BREAKING TIME = 200 ms

Nominal current I_N (A)	Delayed fuse I _{ks} max (A)	DIN gG/gL fuse I _{ks} max (A)	RCD LS-B I _{ks} max (A)	RCD LS-C I _{ks} max (A)	RCD LS-D I _{ks} max (A)
2		19		20	
4		39		40	
6		57	30	60	120
8					
10		97	50	100	200
13		118	65	130	260
16		126	80	160	320
20		171	100	200	400
25		215	125	250	500
32		308	160	320	640
35		374	175	350	700
40		381	200	400	800
50		545	250	500	1000
63		663	315	630	1260
80		965	400	800	1600
100		1195	500	1000	2000
125		1708	625	1250	2500
160		2042			
200		2971			
250		3615			
315		4985			
400		6633			
500		8825			
630					

11.3.4. BREAKING TIME = 100 ms

Nominal current I_N (A)	Delayed fuse I _{ks} max (A)	DIN gG/gL fuse I _{ks} max (A)	RCD LS-B I _{ks} max (A)	RCD LS-C I _{ks} max (A)	RCD LS-D I _{ks} max (A)
2		0			
4		47			
6		72	30	60	120
8		92			
10		110	50	100	200
13		140.4	65	130	260
16		150	80	160	320
20			100	200	400
25		260	125	250	500
32		350	160	320	640
35		453.2	175	350	700
40		450	200	400	800
50		610	250	500	1000
63		820	315	630	1260
80		1100	400	800	1600
100		1450	500	1000	2000
125		1910	625	1250	2500
160		2590			
200		3420			
250		4500			
315		6000			
400		8060			
500					

11.3.5. BREAKING TIME = 35 ms

Nominal current I_N (A)	Delayed fuse I _{ks} max (A)	DIN gG/gL fuse I _{ks} max (A)	RCD LS-B I _{ks} max (A)	RCD LS-C I _{ks} max (A)	RCD LS-D I _{ks} max (A)
2					
4					
6		103	30	60	120
8					
10		166	50	100	200
13		193	65	130	260
16		207	80	160	320
20		277	100	200	400
25		361	125	250	500
32		539	160	320	640
35		618	175	350	700
40		694	200	400	800
50		919	250	500	1000
63		1,217	315	630	1260
80		1,567	400	800	1600
100		2,075	500	1000	2000
125		2,826	625	1250	2500
160		3,538			
200		4,556			
250		6,032			
315		7,767			
400					



FRANCE

Chauvin Arnoux

12-16 rue Sarah Bernhardt

92600 Asnières-sur-Seine

Tél : +33 1 44 85 44 85

Fax : +33 1 46 27 73 89

info@chauvin-arnoux.com

www.chauvin-arnoux.com

INTERNATIONAL

Chauvin Arnoux

Tél : +33 1 44 85 44 38

Fax : +33 1 46 27 95 69

Our international contacts

www.chauvin-arnoux.com/contacts



**CHAUVIN
ARNOUX**